



## AKCESORIA ŻEGLARSKIE



**NIROSTAL Sp. z o.o.**  
80-209 Chwaszczyno, ul. Tuchomska 11  
tel./fax 58 341 92 02, tel. kom 728 355 819  
[www.nirostal.pl](http://www.nirostal.pl), e-mail: [info@nirostal.pl](mailto:info@nirostal.pl)

Spis treści

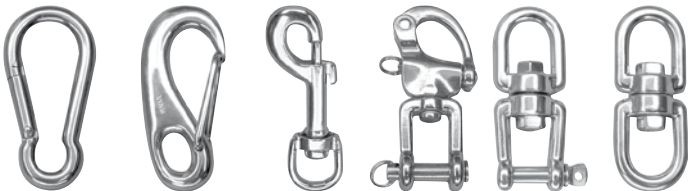
	STRONA
	<p>HAKI SZEKLE</p> <p>3 3-7</p>
	<p>KARABIŃCZYKI KRĘTLIKI</p> <p>8-15 15-16</p>
	<p>ŚCIĄGACZE KOŃCÓWKI PRZETYCZKI</p> <p>17-18 18-21 , 25-27 21</p>
	<p>LINY KAUSZE</p> <p>21-22 23</p>
	<p>ZACISKI ŁĄCZNIKI ZAWLECZKI</p> <p>24 28 28-29</p>
	<p>PRZELOTKI ŁAŃCUCHY ZŁĄCZKI</p> <p>29 30 30-31</p>
	<p>ZAWIASY SKOBLE</p> <p>31-45 45</p>
	<p>KNAGI PRZEWŁOKI U-BOLTY WKRETY OCZKOWE</p> <p>46-47 47 47-48 48</p>

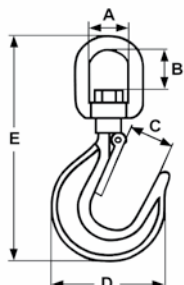
**8971****HAK**

<b>HAK</b>						<b>Stal A4 (316)</b>	
<b>A</b>	<b>B</b>	<b>C</b>	<b>D</b>	<b>E</b>	<b>U (kg)</b>	<b>NR ART.</b>	
28	27	18	69	147	2000	<b>8971428</b>	
36	36	33	97	193	4000	<b>8971436</b>	

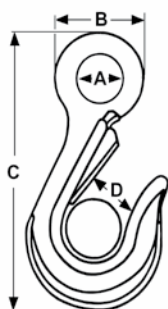
**8287****HAK**

<b>HAK</b>						<b>Stal A4 (316)</b>	
<b>A</b>	<b>B</b>	<b>C</b>	<b>D</b>	<b>U (kg)</b>	<b>NR ART.</b>		
19	33,5	100	20,5	1500	<b>8287419</b>		
28	44,5	115	23	1800	<b>8287428</b>		

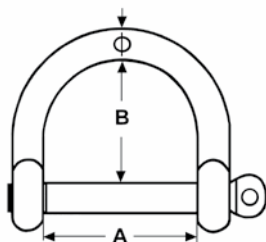
**8969****SZEKLA**

<b>SZEKLA</b>				<b>Stal A4 (316)</b>	
$\Phi$	<b>A</b>	<b>B</b>	<b>U (kg)</b>	<b>NR ART.</b>	
5	25	22	750	<b>8969405</b>	
6	24	36	1350	<b>8969406</b>	
8	26	35	2500	<b>8969408</b>	
10	41	60	3350	<b>8969410</b>	
12	50	76	4000	<b>8969412</b>	

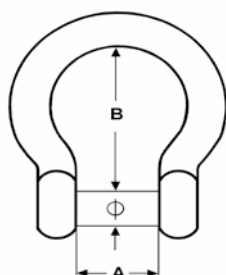
**8970****SZEKLA**

<b>SZEKLA</b>				<b>Stal A4 (316)</b>	
$\Phi$	<b>A</b>	<b>B</b>	<b>U (kg)</b>	<b>NR ART.</b>	
5	11	25	1200	<b>8970405</b>	
6	12	30	1700	<b>8970406</b>	
8	16	44	2500	<b>8970408</b>	
10	21	49	4300	<b>8970410</b>	
12	25	57	6200	<b>8970412</b>	
16	31	80	7000	<b>8970416</b>	
19	36	96	14000	<b>8970419</b>	

**8258****SZEKLA PROSTA, NISKA, TYP „D”**

Stal A4 (316)

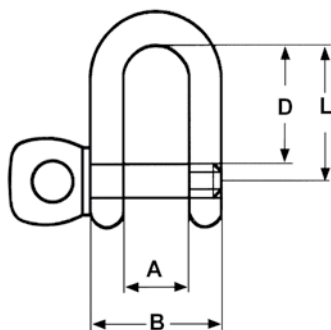

D	A	B	L	U (kg)	NR ART.
4	8	16	16	700	8258404
5	10	20	17	1000	8258405
6	12	24	24	1500	8258406
7	14	28	27	2200	8258407
8	16	32	32	3000	8258408
10	20	40	41	4500	8258410
12	24	48	50	7000	8258412
13	26	52	53	9000	8258413
16	32	64	64	10000	8258416
19	35	76	75	16000	8258419
22	44	88	85	20000	8258422
25	50	100	98	24000	8258425
32	64	128	134	31000	8258432

**8326****SZEKLA PROSTA Z ZABEZPIECZONYM BOLCEM, TYP „D”**

Stal A4 (316)

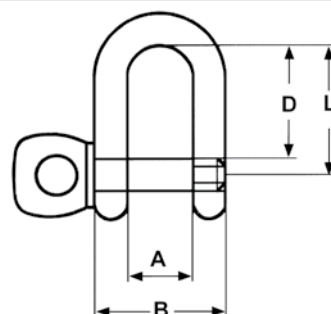

D	A	B	L	U (kg)	NR ART.
5	10	20	19	1100	8326405
6	12	24	24	1600	8326406
8	16	32	32	3200	8326408
10	20	40	39	4900	8326410
12	24	48	42	6600	8326412

**8482****SZEKLA PROSTA Z BOLCEM Z GNIAZDEM IMBUSOWYM**

Stal A4 (316)

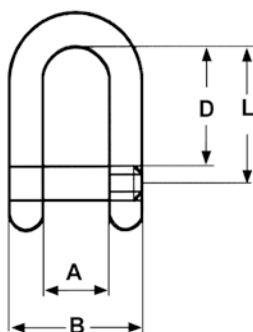

D	A	B	L	U (kg)	NR ART.
5	10	20	19	1000	8482405
6	12	24	21	1500	8482406
8	16	32	32	2200	8482408
10	20	40	40	3700	8482410
12	24	48	51	5400	8482412
14	28	56	56	6500	8482414
16	32	64	60	8800	8482416
19	38	76	73	16000	8482419
22	44	88	87	19000	8482422

**8746****SZEKLA PROSTA ,TYP „D”**

Stal A4 (316)

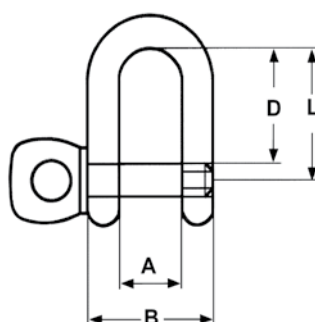

D	A	B	L	U (kg)	NR ART.
4	8	16	17	1080	8746404
5	10	20	20	1550	8746405
6	12	24	24	1860	8746406
8	16	32	33	4380	8746408
10	20	40	40	5800	8746410
12	24	48	49	8100	8746412

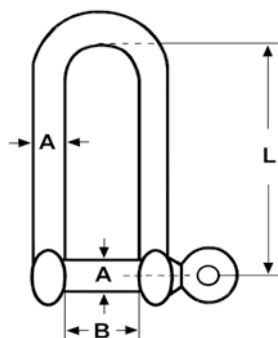
**8259****SZEKLA**

SZEKLA				Stal A4 (316)	
A	B	L	U (kg)	NR ART.	
5	10	40	1000	8259405	
6	12	48	1500	8259406	
8	16	64	3200	8259408	
10	20	80	4900	8259410	
12	24	96	7000	8259412	

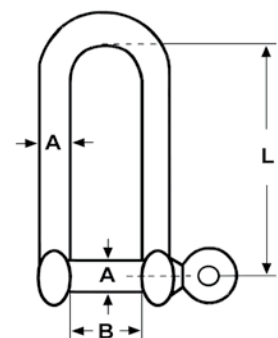
**8331****SZEKLA**

SZEKLA				Stal A4 (316)	
A	B	L	U (kg)	NR ART.	
5	10	40	1000	8331405	
6	12	46	1600	8331406	
8	16	64	3200	8331408	
10	20	80	4900	8331410	
12	24	96	7000	8331412	

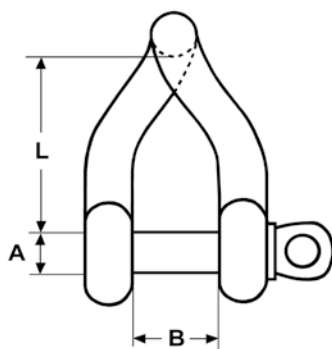
**8296****SZEKLA**

SZEKLA				Stal A4 (316)	
A	B	L	U (kg)	NR ART.	
5	10	32	1200	8296405	
6	12	42	1750	8296406	
8	16	56	3000	8296408	
10	20	65	5800	8296410	
12	24	82	7000	8296412	

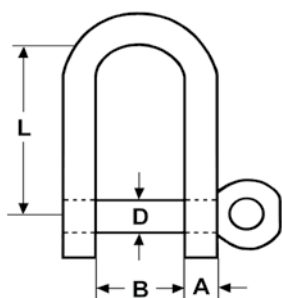
**8337****SZEKLA**

SZEKLA				Stal A4 (316)	
D	B	L	A	U (kg)	NR ART.
5	12	21	2,6	400	833745
6	14	25	3,0	500	833746
8	18	32	3,7	900	833748

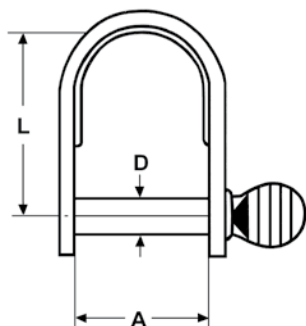
**8297****SZEKLA**

				Stal A4 (316)	
D	A	L	U (kg)	NR ART.	
4	10	17	800	829744	
5	12	20	1100	829745	
6	16	24	2000	829746	

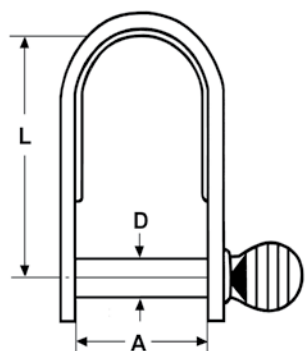
**8298****SZEKLA**

				Stal A4 (316)	
D	A	L	U (kg)	NR ART.	
4	12	26	800	829844	
5	16	27	1100	829845	
6	17	29	2000	829846	

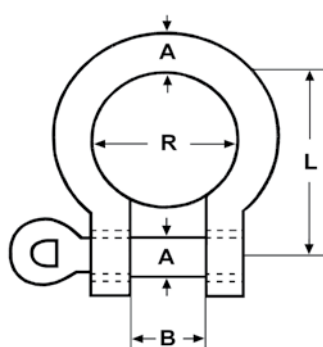
**8260****SZEKLA**

						Stal A4 (316)	
A	B	R	L	D	U (kg)	NR ART.	
4	8	14	16	8	800	8260404	
5	10	17	20	10	1200	8260405	
6	12	21	24	12	1900	8260406	
8	16	28	32	16	2800	8260408	
10	20	34	40	20	4300	8260410	
12	24	42	48	24	6500	8260412	
13	26	45	52	26	7500	8260413	
16	32	56	64	32	12000	8260416	
19	38	66	88	38	18200	8260419	
22	44	66	88	44	21000	8260422	

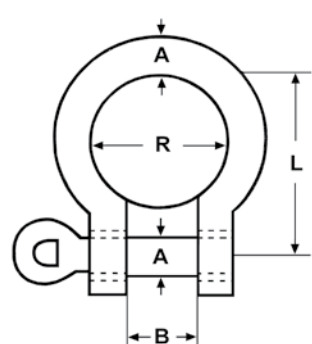
**8222****SZEKLA**

						Stal A4 (316)	
A	B	R	D	L	U (kg)	NR ART.	
5	10	17	10	20	1300	8222405	
6	12	21	12	24	1800	8222406	
8	16	28	16	32	3500	8222408	
10	20	34	20	40	5400	8222410	

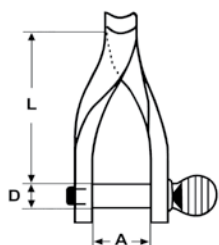
**8299****SZEKLA**

SZEKLA				Stal A4 (316)
D	A	L	U (kg)	NR ART.
4	11	24	800	829944
5	12	40	1400	829945

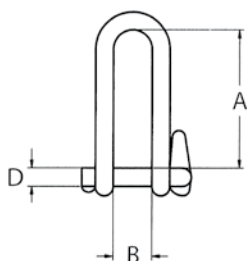
**8324****SZEKLA**

SZEKLA				Stal A4 (316)
D	A	B	U (kg)	NR ART.
5	40	13	954	832445
6	49	16	1363	832446
8	62	22	2272	832448

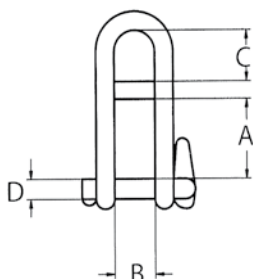
**8323****SZEKLA**

SZEKLA				Stal A4 (316)	
D	A	B	C	U (kg)	NR ART.
5	40	13	12,5	954	832345
6	49	16	15	1363	832346
8	66	21,5	20,5	2272	832348

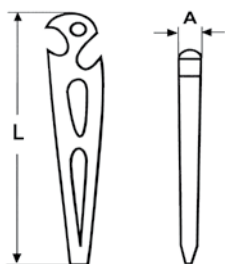
**8306****KLUCZ SZEKLOWY**

KLUCZ SZEKLOWY		Stal A4 (316)
L	A	NR ART.
100	32	83062100

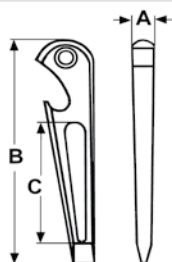
**8977****KLUCZ SZEKLOWY**

KLUCZ SZEKLOWY			Stal A4 (316)
A	B	C	NR ART.
5	86	46	8977405

**8249**

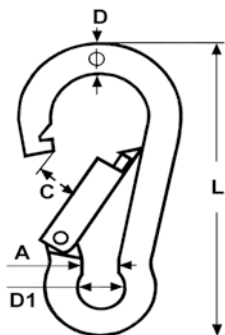

**KARABIŃCZYK**

						Stal A4 (316)
D	L	D1	A	C	U (kg)	NR ART.
3	30	5	4	5,5	250	8249403
4	40	9	5	7	450	8249404
5	50	10	6	8	570	8249405
6	60	11	8	9	670	8249406
7	70	13	8	9	750	8249407
8	80	13	8	9	870	8249408
10	100	16	10	12	1150	8249410
11	120	18	11	16	1250	8249411
12	140	20	13	19	1280	8249412

**8250**

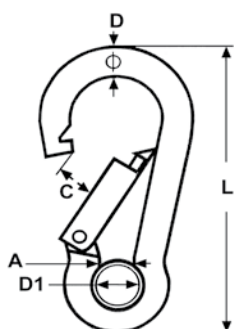

**KARABIŃCZYK Z KAUSZĄ**

						Stal A4 (316)
D	L	D1	A	C	U (kg)	NR ART.
4	40	9	5	7	200	8250404
5	50	10	6	8	400	8250405
6	60	11	8	9	600	8250406
7	70	13	8	9	900	8250407
8	80	13	8	9	1150	8250408
10	100	16	10	12	1450	8250410
11	120	18	11	16	1550	8250411
12	140	20	13	19	1650	8250412

**8232**

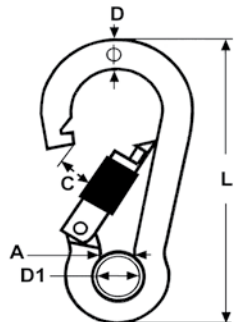

**KARABIŃCZYK Z NAKRĘTKĄ ZABEZPIECZAJĄCĄ**

						Stal A4 (316)
D	L	D1	A	C	U (kg)	NR ART.
8	80	13	8	8	870	8232408
10	100	16	10	10	1150	8232410
11	120	18	11	15	1250	8232411

**8679**

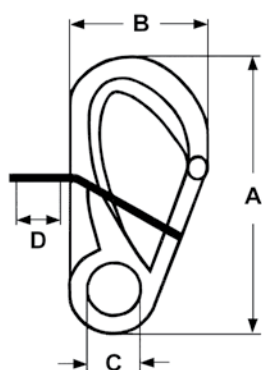

**KARABIŃCZYK**

					Stal A4 (316)
A	B	C	D	U (kg)	NR ART.
108	63	21	35	910	86794108



**8305**

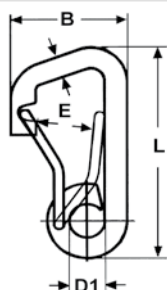

**KARABIŃCZYK**

						Stal A4 (316)
Φ	D1	B	L	E	U (kg)	NR ART.
6	7	35	61	10	600	8305406
8	11	48	81	13	1600	8305408
10	13	58	102	15	2500	8305410
12	16	70	122	21	3000	8305412
16	25	97	165	27	3300	8305416

**8948**

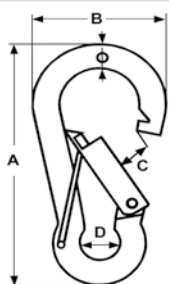

**KARABIŃCZYK**

						Stal A4 (316)
Φ	A	B	C	D	U (kg)	NR ART.
6	60	30	7,5	8,5	272	8948406
8	80	40	10	12	508	8948408
10	100	50	12	15	728	8948410
12	120	60	21	22	908	8948412

**8949**

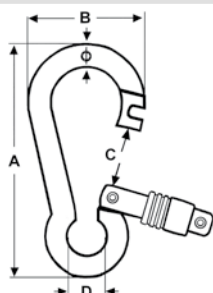

**KARABIŃCZYK**

						Stal A4 (316)
Φ	A	B	C	D	U (kg)	NR ART.
5	50	26	15	8	387	8949405
6	60	30	16	8,5	417	8949406
8	80	40	23	12	990	8949408
10	100	50	27	15	1300	8949410

**8950**

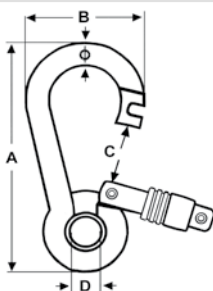

**KARABIŃCZYK**

						Stal A4 (316)
Φ	A	B	C	D	U (kg)	NR ART.
5	50	26	15	7,8	387	8950405
6	60	30	16	7,8	417	8950406
8	80	40	23	10,8	990	8950408
10	100	50	27	14	1300	8950410

**8951**

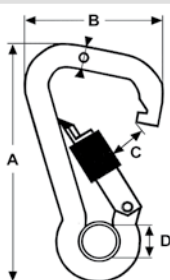

**KARABIŃCZYK**

						Stal A4 (316)
Φ	A	B	C	D	U (kg)	NR ART.
6	60	35	9	8	456	8951406
8	80	46	12,5	11	728	8951408
10	100	60	16	14	1092	8951410
11	120	70	21,5	18	1260	8951411

**8953**

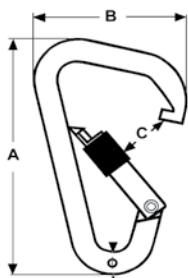

**KARABIŃCZYK**

Stal A4 (316)

Φ	A	B	C	U (kg)
11	120	70	24	1600

NR ART.

**8953411**

**8954**

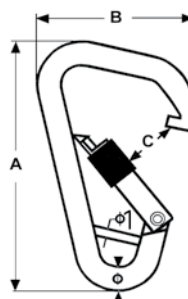

**KARABIŃCZYK**

Stal A4 (316)

Φ	A	B	C	U (kg)
11	120	70	24	1600

NR ART.

**8954411**

**8955**

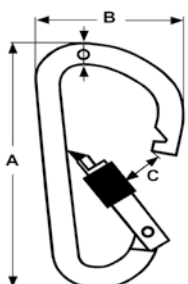

**KARABIŃCZYK**

Stal A4 (316)

Φ	A	B	C	U (kg)
10	115	60	19	2720

NR ART.

**8955410**

**8956**

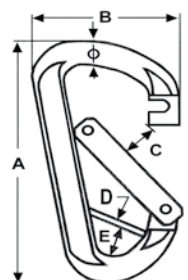

**KARABIŃCZYK**

Stal A4 (316)

Φ	A	B	C	D	E	U (kg)
8	80	45	12	1,7	13	1330
10	100	55	14	2	16	2510

NR ART.

**8956408**

**8956410**

**8957**

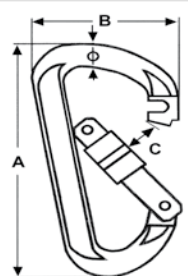

**KARABIŃCZYK**

Stal A4 (316)

Φ	A	B	C	D	E	U (kg)
8	64	45	12	1,7	13	1590
10	80	55	14	2	16	1680

NR ART.

**8957408**

**8957410**

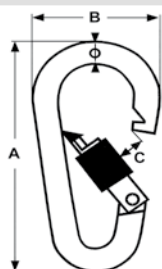
**8958****KARABIŃCZYK**

Stal A4 (316)

$\Phi$	A	B	C	U (kg)	NR ART.
6	60	30	8,5	272	8958406
8	80	40	10	508	8958408
10	100	50	12	728	8958410
11	120	60	17	816	8958411

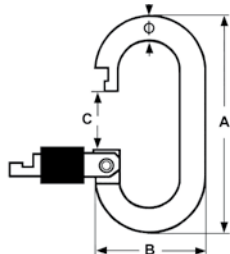
**8959****KARABIŃCZYK**

Stal A4 (316)

$\Phi$	A	B	C	U (kg)	NR ART.
6	55	30	14	440	8959406
8	70	35	18	905	8959408

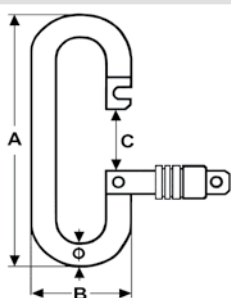
**8960****KARABIŃCZYK**

Stal A4 (316)

$\Phi$	A	B	C	U (kg)	NR ART.
5	70	25	15	370	8960405
6	80	30	16	440	8960406
8	90	35	23	905	8960408
10	100	40	27	1395	8960410

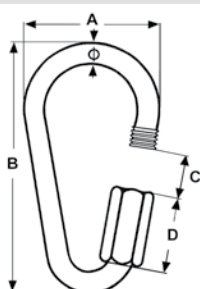
**8961****KARABIŃCZYK**

Stal A4 (316)

$\Phi$	A	B	C	D	U (kg)	NR ART.
4	32	61	11	19	850	8961404
5	37	70	13	22	1350	8961405
6	42	82	14	25	2000	8961406
8	53	100	17	31	3300	8961408
10	63	118	20	36	5500	8961410
12	76	144	23	43	7500	8961412

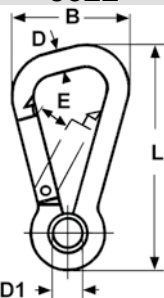
**8322****KARABIŃCZYK**

Stal A4 (316)

D	L	E	D1	B	U (kg)	NR ART.
8	80	13	11	45	870	8322408
10	100	18	14	58	1350	8322410
11	120	24	18	70	1500	8322411

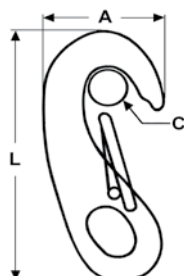
**8251****KARABIŃCZYK**

Stal A4 (316)

L	A	C	U (kg)	NR ART.
50	24	10	200	8251405
70	31	12	700	8251407
100	46	22	1800	8251410

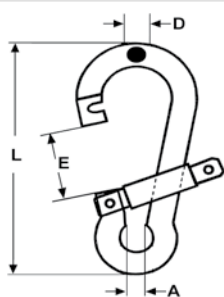
**8293****KARABIŃCZYK**

Stal A4 (316)

D	L	A	E	U (kg)	NR ART.
8	80	8	19	800	8293408
10	100	10,5	22	1200	8293410
11	120	12	26	2000	8293411

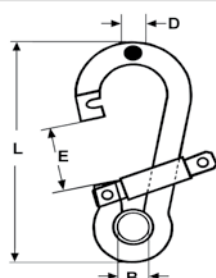
**8294****KARABIŃCZYK**

Stal A4 (316)

D	L	E	B	U (kg)	NR ART.
8	80	19	10	800	8294408
10	100	22	14	1200	8294410
11	120	26	17	2000	8294411

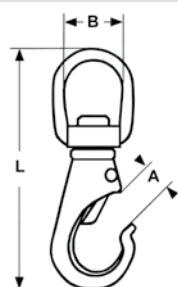
**8257****KARABIŃCZYK**

Stal A4 (316)

A	B	L	U (kg)	NR ART.
5,8	21	86	150	8257416
11,5	21	99,5	250	8257419
13	22	117,5	350	8257422

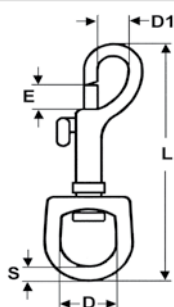
**8303****KARABIŃCZYK Z KRĘTLIKIEM**

Stal A4 (316)

D	D1	S	L	E	NR ART.
9	7	3	62	7	8303409
12	8	4	75	8	8303412
16	9	4	87	9	8303416
19	9	5	90	9	8303419

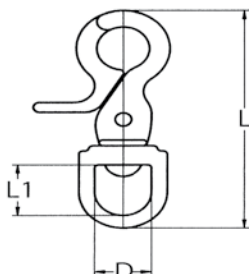
**8534****KARABIŃCZYK Z KRĘTLIKIEM**

				Stal A4 (316)
D	L	L1		NR ART.
13	65	16		8534413
16	65	19		8534416

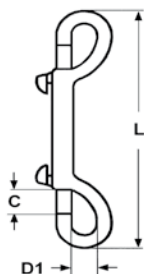
**8416****KARABIŃCZYK**

				Stal A4 (316)
L	C	D1	U (kg)	NR ART.
115	10	11	200	8416411

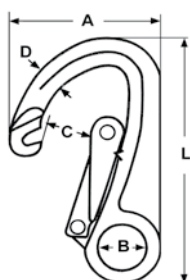
**8338****KARABIŃCZYK**

						Stal A4 (316)
D	L	B	C	A	U (kg)	NR ART.
10	110	20	19	62	1400	8338410

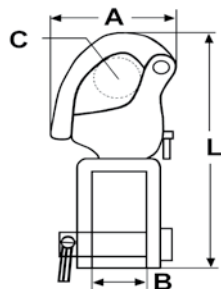
**8262****KARABIŃCZYK Z KRĘTLIKIEM**

					Stal A4 (316)
L	C	A	B	U (kg)	NR ART.
70	12	33	12	1900	8262407
87	16	42	13	2900	8262408
128	22	58	22	3900	8262412

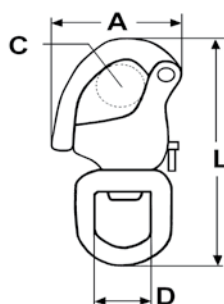
**8252****KARABIŃCZYK Z KRĘTLIKIEM**

					Stal A4 (316)
L	C	D	A	U (kg)	NR ART.
70	12	12	33	1800	8252407
87	16	16	42	2800	8252408
128	22	22	58	3800	8252412

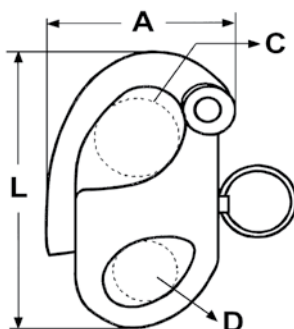
**8288****KARABIŃCZYK**

Stal A4 (316)

L	C	D	A	U (kg)	NR ART.
52	12	9	35	1800	8288452
66	16	12	45	2800	8288466
96	22	16	60	3800	8288496

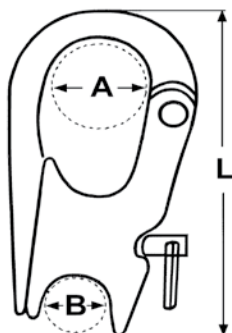
**8290****KARABIŃCZYK**

Stal A4 (316)

L	B	A	NR ART.
52	12	10	8290452
66	15	14	8290466
96	22	18	8290496

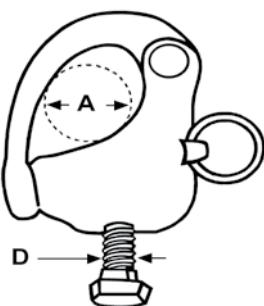
**8289****KARABIŃCZYK**

Stal A4 (316)

D	A	NR ART.
6	12	8289406
8	16	8289408
10	22	8289410

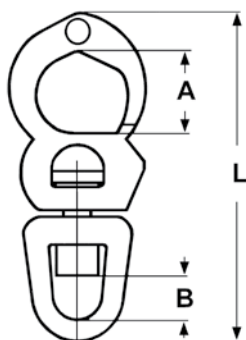
**8661****KARABIŃCZYK Z KRĘTLIKIEM**

Stal A4 (316)

L	A	B	U (kg)	NR ART.
85	18	12	1500	8661408
105	24	14	2500	8661410
125	27	18	3500	8661412

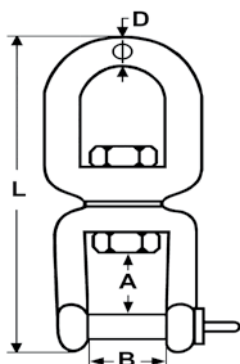
**8255****KRETLIK**

					Stal A4 (316)	
D	L	B	A	U (kg)	NR ART.	
6	66	12	11	1350	8255406	
8	94	16	16	2500	8255408	
10	118	22	22	3500	8255410	
13	152	28	28	6000	8255413	
16	188	37	37	9800	8255416	
19	229	38	45	15000	8255419	

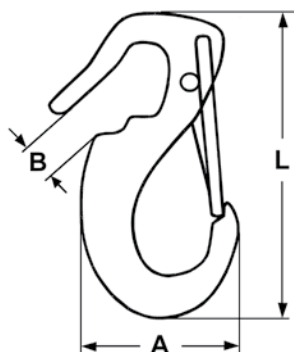
**8533****KARABIŃCZYK**

				Stal A4 (316)	
L	A	B	U (kg)	NR ART.	
50	25	6,5	250	8533450	
65	35	10	550	8533465	
90	49	13	1000	8533490	

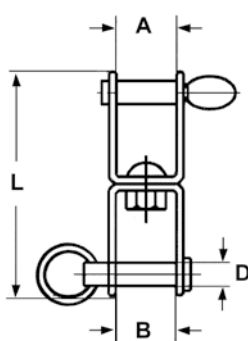
**8364****KRETLIK**

					Stal A4 (316)	
A	B	L	D	NR ART.		
12	12	47	5	8364212		
14	14	55	6	8364214		

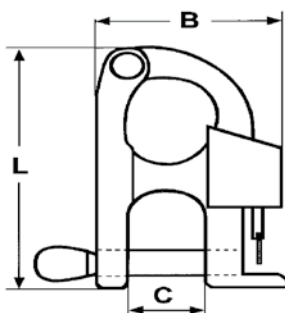
**8485****KARABIŃCZYK**

				Stal A4 (316)	
C	L	B	U (kg)	NR ART.	
16	60	36,5	800	8485460	

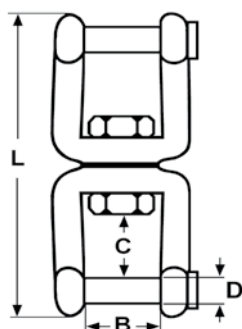
**8535****KRĘTLIK**

KRETLIK					Stal A4 (316)	
D	L	B	C	U (kg)	NR ART.	
5	60	10	11	600	8535405	
6	66	12	11	1350	8535406	
8	94	16	16	2500	8535408	
10	118	20	22	3500	8535410	
13	152	26	28	6000	8535413	
16	188	32	37	10800	8535416	
19	229	38	45	16100	8535419	

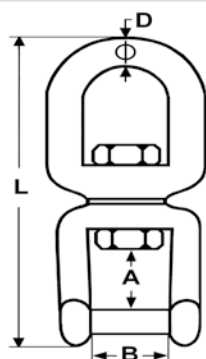
**814105****KRĘTLIK**

KRETLIK					Stal A4 (316)	
D	L	A	B	U (kg)	NR ART.	
5	60	11	10	100	814105405	
6	66	12	12	150	814105406	
8	92	16	16	300	814105408	
10	118	22	20	500	814105410	
13	152	28	26	1000	814105413	
16	188	37	32	1500	814105416	
19	229	44	38	2000	814105419	

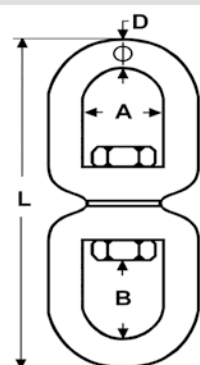
**8254****KRĘTLIK**

KRETLIK					Stal A4 (316)	
D	L	B	A	U (kg)	NR ART.	
5	60	13	13	820	8254405	
6	65	15	15	1350	8254406	
8	90	22	20	2500	8254408	
10	115	27	24	3500	8254410	
13	154	35	32	6000	8254413	
16	188	45	39	10800	8254416	
19	231	50	41	16100	8254419	

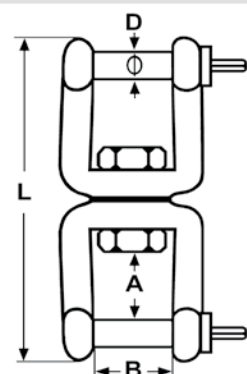
**8256****KRĘTLIK**

KRETLIK					Stal A4 (316)	
D	L	B	A	U (kg)	NR ART.	
5	60	10	11	600	8256405	
6	66	12	11	1350	8256406	
8	94	16	16	2500	8256408	
10	118	20	22	3500	8256410	
13	152	28	28	6000	8256413	
16	188	37	37	9800	8256416	
19	229	38	45	1500	8256419	

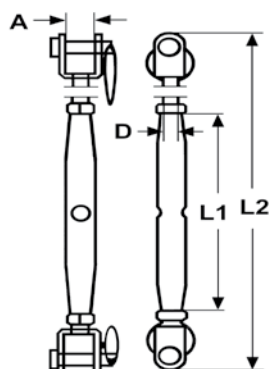

**8245****ŚCIĄGACZ**

							Stal A4 (316)
GW	L1	L2	A	D	U (kg)	NR ART.	
M5	130	190	8	5	900	<b>8245405</b>	
M6	140	210	8	5	1250	<b>8245406</b>	
M8	165	240	9,5	6	1750	<b>8245408</b>	
M10	190	270	10	8	3500	<b>8245410</b>	
M12	245	360	11	10	5100	<b>8245412</b>	
M14	270	400	14	12	5900	<b>8245414</b>	
M16	310	450	14	14	8000	<b>8245416</b>	
M20	385	545	22	15	13000	<b>8245420</b>	

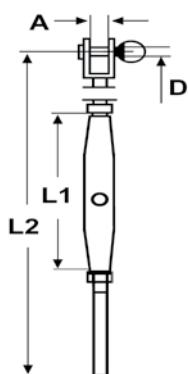
**8275****ŚCIĄGACZ**

							Stal A4 (316)
GW	DS-Ø	L1	L2	A	D	U (kg)	NR ART.
M5	2,5	155	220	8	5	900	<b>8275405</b>
M6	3	170	250	8	5	1250	<b>8275406</b>
M8	4	200	295	10	6	1750	<b>8275408</b>
M10	5	220	325	10	8	3500	<b>8275410</b>
M12	6	280	410	11	10	5100	<b>8275412</b>
M14	7	315	470	14	12	5900	<b>8275414</b>
M16	8	340	510	14	14	8000	<b>8275416</b>
M20	10	410	600	24	16	13000	<b>8275420/10</b>
M20	12	430	620	23	15,5	13000	<b>8275420/12</b>

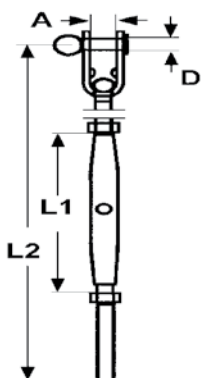
**8276****ŚCIĄGACZ**

							Stal A4 (316)
GW	DS-Ø	L1	L2	A	D	U (kg)	NR ART.
M6	3	172	242	7	8	600	<b>8276406</b>
M8	4	207	287	10	8	1100	<b>8276408</b>
M10	5	241	326	12	9	1750	<b>8276410</b>
M12	6	292	407	13	12	2300	<b>8276412</b>
M14	7	328	453	15	14	3600	<b>8276414</b>
M16	8	389	534	17	16	6800	<b>8276416</b>
M20	10	451	591	20	19	8200	<b>8276420</b>

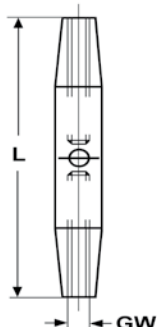
**8418****ŚCIĄGACZ SAM KORPUS**

		Stal A4 (316)
GW	L	NR ART.
M6	95	<b>8418406</b>
M8	105	<b>8418408</b>
M10	125	<b>8418410</b>
M12	150	<b>8418412</b>
M16	190	<b>8418416</b>
M20	210	<b>8418420</b>

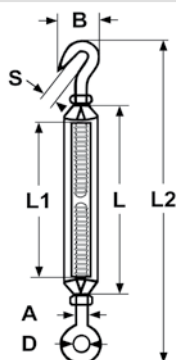
**8246****ŚCIĄGACZ**

								Stal A4 (316)
GW	L	L1	L2	B	D	S	U (kg)	NR ART.
M5	70	52	120	13	8	9	160	<b>82464 * 05</b>
M6	90	66	160	16	10	10	320	<b>82464 * 06</b>
M8	120	94	200	20	14	11	560	<b>82464 * 08</b>
M10	150	120	240	28	16	12	880	<b>82464 * 10</b>
M12	200	168	300	36	18	14	1200	<b>82464 * 12</b>
M16	250	210	390	40	26	16	2400	<b>82464 * 16</b>
M20	300	245	440	50	30	18	3600	<b>82464 * 20</b>

\*) A- (OKO-OKO), B-(HAK-HAK), C-(OKO-HAK)

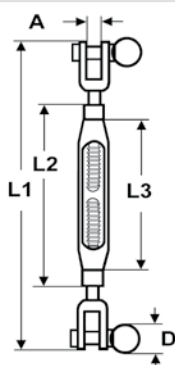
**8339****ŚCIĄGACZ**

								Stal A4 (316)
GW	L1	L2	L3	A	D	U (kg)	NR ART.	
M5	170	115	70	7	5	500	<b>8339405</b>	
M6	200	130	90	8	6	600	<b>8339406</b>	
M8	250	160	120	12	8	1100	<b>8339408</b>	
M10	320	200	150	12	9	1750	<b>8339410</b>	
M12	430	300	200	15	14	2300	<b>8339412</b>	
M14	400	270	170	15	14	3600	<b>8339414</b>	
M16	450	325	210	17	16	6800	<b>8339416</b>	
M20	490	345	265	20	19	8200	<b>8339420</b>	

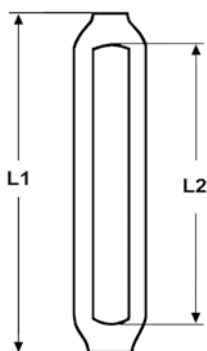
**8417****ŚCIĄGACZ SAM KORPUS**

				Stal A4 (316)
GW	L	L1	NR ART.	
M6	90	66	<b>8417406</b>	
M8	120	94	<b>8417408</b>	
M10	150	120	<b>8417410</b>	
M12	200	168	<b>8417412</b>	
M16	250	210	<b>8417416</b>	
M20	300	245	<b>8417420</b>	

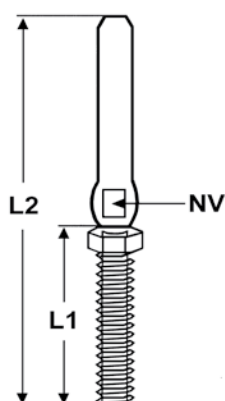
**8307****KOŃCÓWKA DO ZAKLEPYWANIA Z PRAWYM GWINTEM**

						Stal A4 (316)
GW	DS-Φ	L1	L2	NV	NR ART.	
M5	2,5	40	86	4	<b>8307405</b>	
M6	3	48	100	5	<b>8307406/3</b>	
M6	4	48	110	6	<b>8307406/4</b>	
M8	4	57	117	6	<b>8307408</b>	
M10	5	63	130	7	<b>8307410</b>	
M12	6	80	162	10	<b>8307412</b>	
M14	7	90	180	12	<b>8307414</b>	
M16	8	100	195	14	<b>8307416</b>	
M20	10	119	230	15	<b>8307420/10</b>	
M20	12	120	245	17	<b>8307420/12</b>	
M22	14	140	308	22	<b>8307422</b>	
M24	12	160	363	25	<b>8307424</b>	

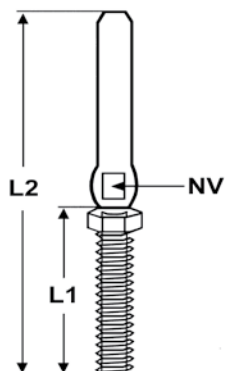
**8467****KOŃCÓWKA DO ZAKLEPYWANIA Z LEWYM GWINTEM**

					Stal A4 (316)
GW	DS- $\Phi$	L1	L2	NV	NR ART.
M5	2,5	40	86	4	8467405
M6	3	48	100	5	8467406/3
M6	4	48	110	6	8467406/4
M8	4	57	117	6	8467408
M10	5	63	130	7	8467410
M12	6	80	162	10	8467412
M14	7	90	180	12	8467414
M16	8	100	195	14	8467416
M20	10	119	230	15	8467420/10
M20	12	120	245	17	8467420/12

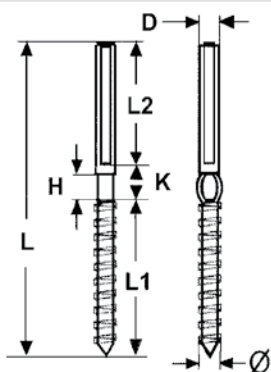
**814087****KOŃCÓWKA**

								Stal A4 (316)
lina- $\Phi$	D	$\Phi$	L	L1	L2	K	H	NR ART.
3	6,3	6	97	48	38	5	8	814087403
4	7,5	8	115	54	45	6	10	814087404
5	9	10	128	61	52	7	10	814087405
6	12,5	12	162	79	63	10	10	814087406

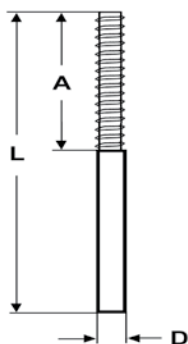
**8484****KOŃCÓWKA DO ZAWALCOWANIA Z PRAWYM GWINTEM**

				Stal A4 (316)
GW	L	A	D	NR ART.
M5	85	40	4,4	8484405
M6	100	45	5,2	8484406
M8	112	52	7,0	8484408
M10	127	62	8,8	8484410
M12	140	75	10,7	8484412
M14	150	82	12,5	8484414
M16	170	95	14,2	8484416
M20	185	105	18,1	8484420

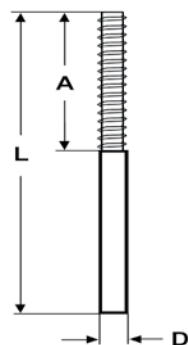
**8511****KOŃCÓWKA DO ZAWALCOWANIA Z LEWYM GWINTEM**

				Stal A4 (316)
GW	L	A	D	NR ART.
M5	85	40	4,4	8511405
M6	100	45	5,2	8511406
M8	112	52	7,0	8511408
M10	127	62	8,8	8511410
M12	140	75	10,7	8511412
M14	150	82	12,5	8511414
M16	170	95	14,2	8511416
M20	185	105	18,1	8511420

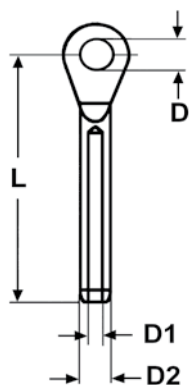
**8281****KOŃCÓWKA**

						Stal A4 (316)
DS- $\phi$	D	D1	D1	L	NR ART.	
2,5	6,5	2,6	5,4	46	8281402	
3	6,5	3,2	6,5	55	8281403	
4	8,5	4,3	7,5	61	8281404	
5	10,5	5,3	9	76	8281405	
6	12,5	6,3	12,5	90	8281406	
7	12,5	7,3	14	99	8281407	
8	14,5	8,3	16	110	8281408	
10	19,3	10,5	17,5	132	8281410	
12	19,3	12,5	19,5	160	8281412	

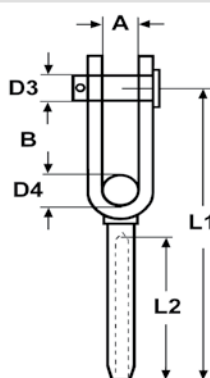
**8483****KOŃCÓWKA**

							Stal A4 (316)
DS- $\phi$	L1	L2	D3	D4	A	B	NR ART.
3	75	38	6	7	7	15	8483403
4	89	45	8	10	10	20	8483404
5	104	51	9	12	12	25	8483405
6	127	64	12	13	13	30	8483406
8	163	76	16	17	17	40	8483408
10	184	89	19	20	20	45	8483410

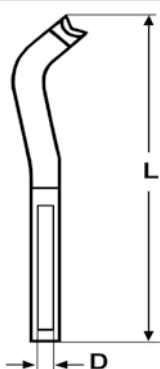
**8282****KOŃCÓWKA**

		Stal A4 (316)
DS- $\phi$	L	NR ART.
3	85	8282403
4	100	8282404
5	115	8282405
6	140	8282406
7	145	8282407
8	185	8282408
10	215	8282410

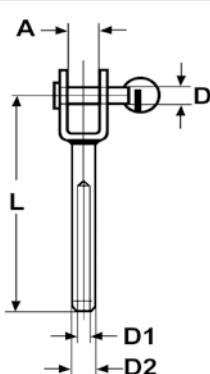
**8280****KOŃCÓWKA**

						Stal A4 (316)
DS- $\phi$	D	D1	D2	A	L	NR ART.
2,5	5	2,7	5,5	8	61	8280402
3	5	3,3	6,4	8	65	8280403
4	6	4,2	7,5	9,5	73	8280404
5	8	5,2	9	10	84	8280405
6	10	6,8	12,5	11	102	8280406
7	12	7,6	14,3	14	117	8280407
8	12	8,4	16,1	14	122	8280408
10	15	10,5	20,6	22	151	8280410
12	15	12,6	24,8	22	195	8280412
14	22	14,5	25	30	232	8280414
16	25,4	17	28	30	264	8280416

**8278**

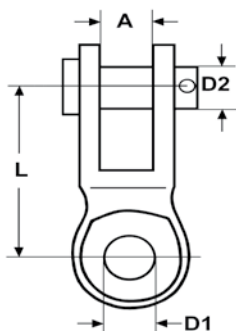

**PRZETYCZKA**

Stal A4 (316)

linka	D1	D2	A	L	NR ART.
5	5,5	5,2	6	22	8278405
6	6,6	6,3	7	27	8278406
8	8,5	8,3	10	31	8278408
10	10,5	9,3	12	36	8278410
12	13	12,4	13	50	8278412
14	15	15	15	60	8278414
16	16,5	17	14	80	8278416

**8486**

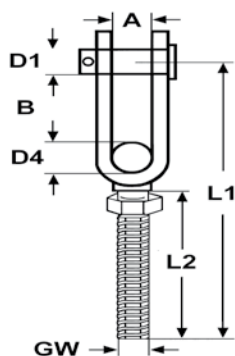

**KOŃCÓWKA PRAWY GWINT**

Stal A4 (316)

GW	L2	L1	D1	D4	A	B	NR ART.
M5	42	62	5	6	6	13	8486405
M6	48	77	6	7	7	15	8486406
M8	56	94	8	10	10	20	8486408
M10	67	115	9	12	12	25	8486410
M12	81	136	12	13	13	30	8486412
M14	89	140	14	15	15	35	8486414
M16	103	163	16	17	17	40	8486416
M20	115	198	19	20	20	45	8486420

**8503**

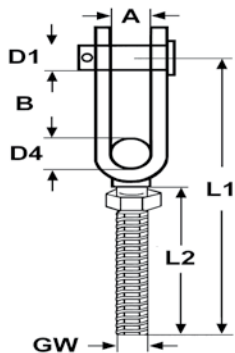

**KOŃCÓWKA LEWY GWINT**

Stal A4 (316)

GW	L2	L1	D1	D4	A	B	NR ART.
M5	42	62	5	6	6	13	8503405
M6	48	77	6	7	7	15	8503406
M8	56	94	8	10	10	20	8503408
M10	67	115	9	12	12	25	8503410
M12	81	136	12	13	13	30	8503412
M14	89	140	14	15	15	35	8503414
M16	103	163	16	17	17	40	8503416
M20	115	198	19	20	20	45	8503420

**8382**

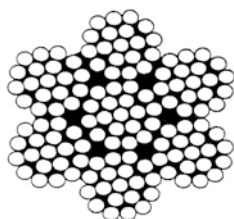

**LINA 7X19**

Stal A4 (316)

DS-Φ	waga kg/m	obliczeniowa siła zrywająca w kN	minimalna siła zrywająca w kN	NR ART.
2	0,015	2,65	2,33	8382402
2,5	0,023	4,17	3,66	83824025
3	0,035	5,86	4,69	8382403
4	0,061	10,4	8,34	8382404
5	0,096	16,3	13	8382405
6	0,138	23,4	18,8	8382406
7	0,187	31,97	25,5	8382407
8	0,243	41,7	33,3	8382408
10	0,381	65,1	52,1	8382410
12	0,548	93,7	75	8382412
14	0,764	128	102	8382414

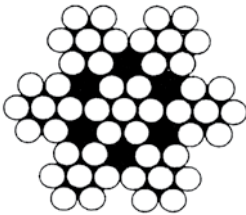
8379	LINA 7X7				Stal A4 (316)
	DS- $\emptyset$	waga kg/m	obliczeniowa siła zrywająca w kN	minimalna siła zrywająca w kN	NR ART.
	1	0,004	0,71	0,63	8379401
	1,5	0,009	1,62	1,42	83794015
	2	0,016	2,69	2,25	8379402
	2,5	0,025	4,5	3,95	83794025
	3	0,035	6,05	5,07	8379403
	4	0,063	10,8	9,01	8379404
	5	0,098	16,8	14,1	8379405
	6	0,142	24,2	20,3	8379406
	7	0,193	33	27,6	8379407
	8	0,252	43	36,1	8379408
	10	0,393	67,2	56,3	8379410

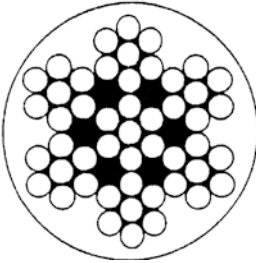
8381	LINA 7X7 W OSŁONIE PVC			Stal A4 (316)
	DS- $\emptyset$	kolor		NR ART.
	4/6	biały		8381446
	4/7	biały		8381447

8378	LINA 1X19				Stal A4 (316)
	DS- $\emptyset$	waga kg/m	obliczeniowa siła zrywająca w kN	minimalna siła zrywająca w kN	NR ART.
	1	0,005	0,94	0,83	8378401
	1,5	0,012	2,11	1,86	83784015
	2	0,02	3,75	3,3	8378402
	2,5	0,031	5,86	5,15	83784025
	3	0,045	8,43	7,42	8378403
	4	0,08	15	13,2	8378404
	5	0,124	23,4	20,6	8378405
	6	0,178	33,7	29,7	8378406
	7	0,243	45,9	40,4	8378407
	8	0,317	60	52,8	8378408
	10	0,495	93,7	82,5	8378410
	12	0,713	135	119	8378412
	14	0,971	184	162	8378414
16	1,27	240	211	8378416	

## 8247

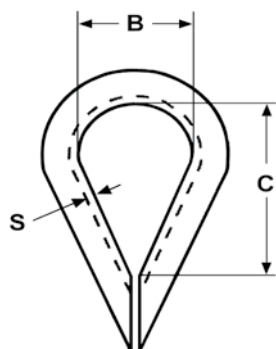

## KAUSZA

KAUSZA				Stal A4 (316)
lina $\Phi$	B	C	S	NR ART.
2	7	10	0,7	8247402
2,5	8	14	0,7	82474025
3	9	15	1	8247403
4	11	18	1	8247404
5	14	20	1,2	8247405
6	15	23	1,2	8247406
8	18	29	1,5	8247408
10	24	37	1,5	8247410
12	29	50	1,5	8247412
14	33	54	2	8247414
16	37	64	2	8247416
18	40	70	2,5	8247418
20	45	75	2,5	8247420
24	48	79	2,5	8247424

## 8636

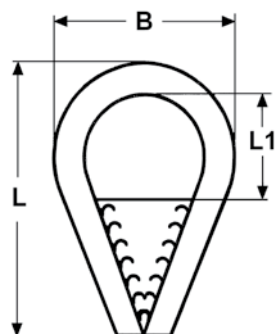

## KAUSZA

KAUSZA				Stal A4 (316)
lina $\Phi$	B	L	L1	NR ART.
6	23	37	11	8636406
8	31	50	15	8636408
10	39	53	21	8636410
12	42	60	25	8636412
14	51	74	30	8636414

## 8536

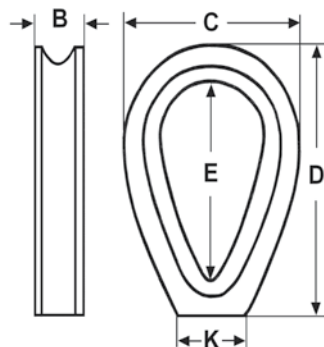

## KAUSZA

KAUSZA						Stal A4 (316)
lina $\Phi$	B	C	D	E	K	NR ART.
2	5	15	21	15	6,4	8536402
3	6	20	26	18	8,4	8536403
4	7	25	32	21	11	8536404
5	7	25	32	21	11	8536405
6	9	32	43	28	11	8536406
8	10	41	58	43	13	8536408
10	13	50	72	51	14	8536410
12	16	60	86	62	16	8536412
16	20	75	110	82	21	8536416
19	24	90	124	94	31	8536419
22	28	100	130	100	38	8536422
25	32	116	148	115	48	8536425

**8248**

**ZACISK LINOWY KABŁAKOWY**

Stal A4 (316)

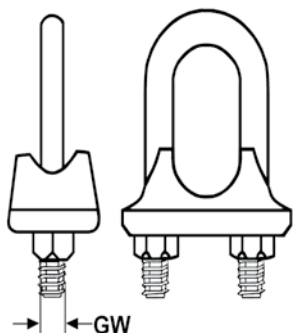

lina $\Phi$	GW	NR ART.
2	3	8248402
3	3	8248403
4	4	8248404
5	5	8248405
6	6	8248406
8	6	8248408
10	8	8248410
13	10	8248413
16	10	8248416
18	12	8248418
22	12	8248422

**8284**

**ZACISK LINOWY RYNIENKOWY**

Stal A4 (316)

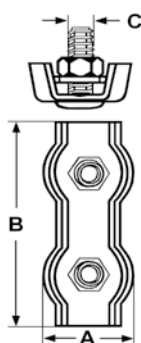

lina $\Phi$	A	B	C	NR ART.
2	11,5	33	M4	8284402
3	14,5	38	M4	8284403
4	16,5	43	M5	8284404
5	20	51	M5	8284405
6	24,5	63	M6	8284406
8	31,5	78	M8	8284408
10	38	96	M10	8284410

**8304**

**ZACISK LINOWY RYNIENKOWY**

Stal A4 (316)

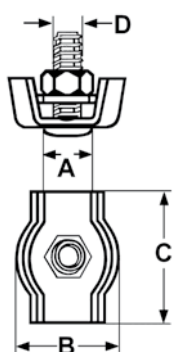

lina $\Phi$	D	A	B	C	NR ART.
2	M4	4	11,5	15	8304402
3	M4	6	14,5	18	8304403
4	M5	8	16,5	20	8304404
5	M5	10	20	24	8304405
6	M6	12	24,5	29	8304406
8	M8	16	31,5	35	8304408
10	M10	20	38	48	8304410

**8452**

**KOŃCÓWKA SZCZĘKOWA GWINT PRAWY**

Stal A4 (316)

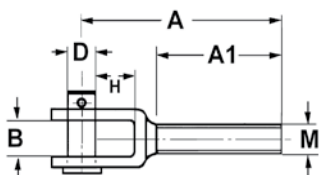

M	A	A1	H	B	D	NR ART.
5	40	20	10	8	5	8452205
6	47	25	10	8	6	8452206
8	52	25	12	10	8	8452208
10	72	45	14	12	10	8452210



**8453****KOŃCÓWKA SZCZĘKOWA LEWY GWINT**

Stal A4 (316)

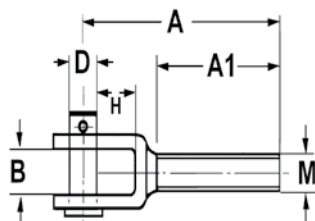

M	A	A1	H	B	D	NR ART.
5	40	20	10	8	5	8453205
6	47	25	10	8	6	8453206
8	52	25	12	10	8	8453208
10	72	45	14	12	10	8453210

**8454****KOŃCÓWKA OCZKOWA PRAWY GWINT**

Stal A4 (316)

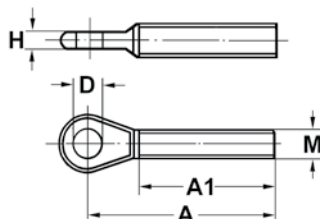

M	A	A1	D	H	NR ART.
5	45	23	5,5	3	8454205
6	47	28	6,5	4	8454206
8	55	40	8,5	5	8454208
10	65	47	10,5	6	8454210

**8458****KOŃCÓWKA OCZKOWA LEWY GWINT**

Stal A4 (316)

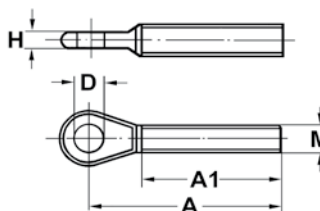

M	A	A1	D	H	NR ART.
5	45	23	5,5	3	8458205
6	47	28	6,5	4	8458206
8	55	40	8,5	5	8458208
10	65	47	10,5	6	8458210

**8455****KOŃCÓWKA Z GWINTEM WEWNĘTRZNYM PRAWYM**

Stal A4 (316)

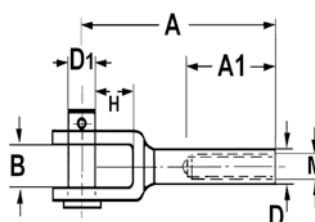

M	D	H	B	D1	A	A1	NR ART.
5	7,5	10	8	5	55	27	8455205
6	8	10	9	6	60	30	8455206
8	12	12	10	8	65	31	8455208
10	14	12	12	10	75	40	8455210

**8456****KOŃCÓWKA Z GWINTEM WEWNĘTRZNYM LEWYM**

Stal A4 (316)

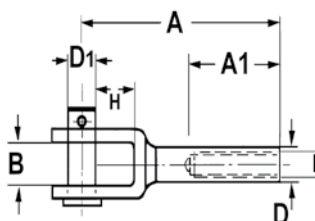

M	D	H	B	D1	A	A1	NR ART.
5	7,5	10	8	5	55	27	8456205
6	8	10	9	6	60	30	8456206
8	12	12	10	8	65	31	8456208
10	14	12	12	10	75	40	8456210

**8457****ŚCIĄGACZ SAM KORPUS**

Stal A4 (316)

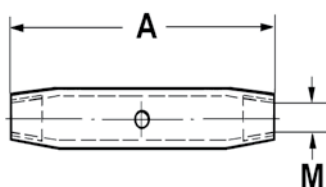

M	A	NR ART.
5	55	8457205
6	65	8457206
8	70	8457208
10	85	8457210

**8451****TERMINAL ŚRUBOWY**

Stal A4 (316)

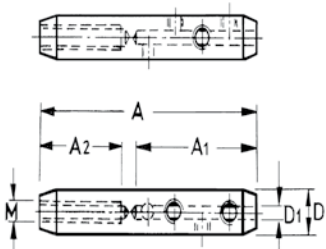

Φ	M	D	D1	A	A1	A2	NR ART.
PRAWY 3+4	6P	12	4,3	80	45	30	84514R
LEWY 3+4	6L	12	4,3	80	45	30	84514L

**8466****KOŃCÓWKA Z GWINTEM PRAWYM I LEWYM**

Stal A4 (316)

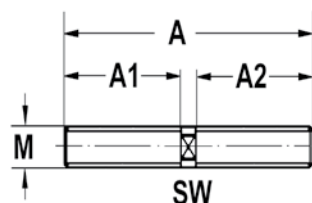

M	A	A1	A2	NR ART.
5	65	30	30	8466405
6	65	30	30	8466406
8	65	30	30	8466408
10	85	40	40	8466410
12	105	50	50	8466412

**8469****KOŃCÓWKA**

Stal A4 (316)

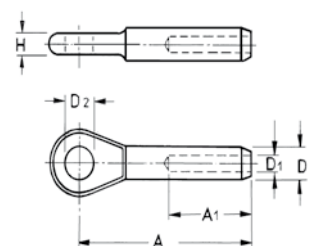

Φ	D	D1	D2	A	A1	H	NR ART.
3	6,3	3,3	6,5	40	18	5	846923
4	7,5	4,3	8,5	52	24	6	846924
5	9,0	5,3	9,5	62	30	7	846925
6	12,5	6,3	13	75	36	8	846926

**8445****KOŃCÓWKA Z GWINTEM PRAWYM**

Stal A4 (316)

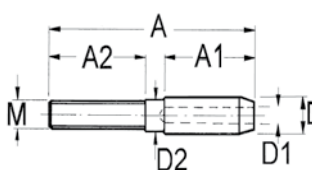

Φ	M	D	D1	A	A1	A2	NR ART.
3	5	6,3	3,3	50	18	27	8445205
4	6	7,5	4,3	60	25	30	8445206
5	8	9,0	5,3	70	31	31	8445208
6	10	12,5	6,3	85	37	40	8445210

**8446****KOŃCÓWKA Z GWINTEM LEWYM**

Stal A4 (316)

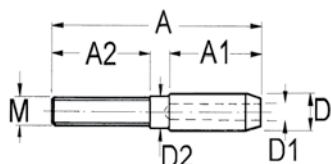

lina $\Phi$	M	D	D1	A	A1	A2	NR ART.
3	5	6,3	3,3	50	18	27	<b>8446205</b>
4	6	7,5	4,3	60	25	30	<b>8446206</b>
5	8	9,0	5,3	70	31	31	<b>8446208</b>
6	10	12,5	6,3	85	37	40	<b>8446210</b>

**8449****KOŃCÓWKA Z PRAWYM GWINTEM**

Stal A4 (316)

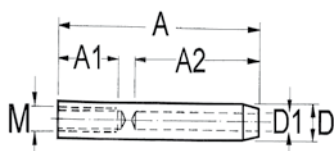

lina $\Phi$	M	D	D1	A	A1	A2	NR ART.
3	5	6,3	3,3	55	20	28	<b>8449205</b>
4	6	7,5	4,3	65	22	36	<b>8449206/4</b>
5	6	9,0	5,3	70	22	41	<b>8449206/5</b>
6	8	12,5	6,3	85	25	53	<b>8449208</b>

**8450****KOŃCÓWKA Z LEWYM GWINTEM**

Stal A4 (316)

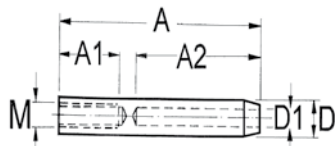

lina $\Phi$	M	D	D1	A	A1	A2	NR ART.
3	5	6,3	3,3	55	20	28	<b>8450205</b>
4	6	7,5	4,3	65	22	36	<b>8450206/4</b>
5	6	9,0	5,3	70	22	41	<b>8450206/5</b>
6	8	12,5	6,3	85	25	53	<b>8450208</b>

**8447****KOŃCÓWKA**

Stal A4 (316)

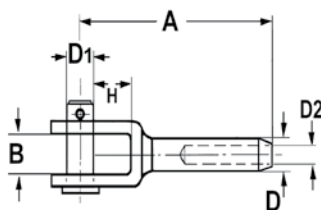

lina $\Phi$	D	D1	D2	A	B	H	NR ART.
3	6,3	5	3,3	55	8	10	<b>844723</b>
4	7,5	6	4,3	65	8	10	<b>844724</b>
5	8,9	8	5,3	70	10	12	<b>844725</b>
6	12,4	10	6,3	85	12	14	<b>844726</b>

**8459****KOŃCÓWKA**

Stal A4 (316)

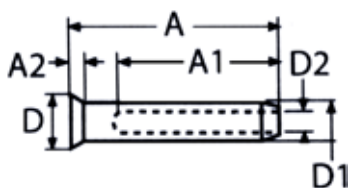

lina $\Phi$	D	D1	D2	A	A1	A2	NR ART.
3	8	6,3	3,3	34	27	2	<b>845923</b>
4	9,5	7,5	4,3	43	35	2	<b>845924</b>
5	13	9	5,3	50	40	3	<b>845925</b>
6	16,5	12,5	6,3	64	50	3	<b>845926</b>

**8448**

**KOŃCÓWKA**

Stal A4 (316)

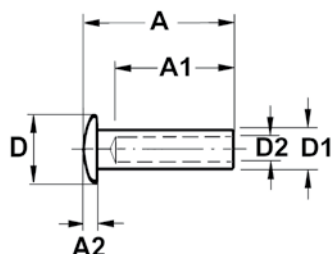

lina $\Phi$	D	D1	D2	A	A1	A2	NR ART.
3	9	5,5	3,3	25	18	2	844823
4	11	6,5	4,3	30	24	2	844824
5	13	7,5	5,3	35	28	2,5	844825
6	16	9	6,3	40	32	3	844826

**8464**

**ŚRUBA Z WEWNĘTRZNYM GWIEM I WPUSTEM IMBUSOWYM**

Stal A4 (316)

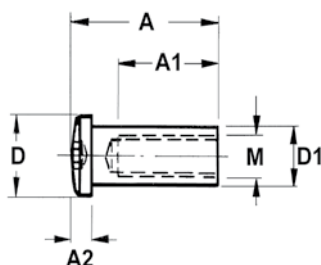

M	D	D1	A	A1	A2	NR ART.
5	12	7,5	25	18	4	8464205
6	12	8	30	24	4	8464206
8	16	12	35	28	5	8464208
10	20	14	40	32	6	8464210

**8515**

**ŁĄCZNIK**

Stal A4 (316)

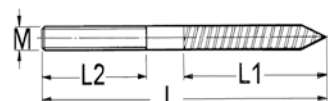

M	L	L1	L2	NR ART.
5	80	43	32	8515405
6	90	50	35	8515406
8	130	65	55	8515408
10	150	75	55	8515410

**8516**

**ŁĄCZNIK**

Stal A4 (316)

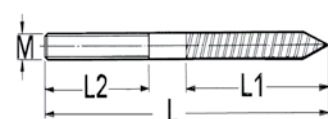

M	L	L1	L2	NR ART.
5	80	43	32	8516405
6	90	50	35	8516406
8	130	65	55	8516408
10	150	75	55	8516410

**814076**

**ZAWLECZKA**

Stal A4 (316)

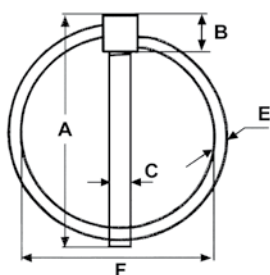

A	B	C	E	F	NR ART.
49,6	7,5	4,4	2,4	39	8140764440
56,2	8	6	3,2	44,8	8140764600
56,5	8,4	7,4	3,1	44,9	8140764790
56,5	10,7	10,6	3,2	43,4	8140764106

8273	ZAWLECZKA	Stal A4 (316)		
	$\Phi$	L		NR ART.
	2	48		827322
	2,5	48		8273225
	3	70		827323
	4	76		827324
	5	100		827325
	6	125		827326

8431	ZAWLECZKA	Stal A4 (316)		
	$\Phi$	L		NR ART.
	2,5	54		8431425
	3,2	61		8431432
	4	78		8431440
	5	97		8431450
	6,3	115		8431463
	7	146		8431470
8	172		8431480	

8226	PRZELOTKA	Stal A4 (316)			
	D	L	B	H	NR ART.
	4	40	16	3,2	8226204
	5	50	18	4,2	8226205
	6	60	22	5	8226206
	8	63	24	6	8226208
	10	75	28	8,2	8226210

8227	PRZELOTKA	Stal A4 (316)			
	D	L	B	oczko - $\Phi$	NR ART.
	5	48	15	9,5	8227405

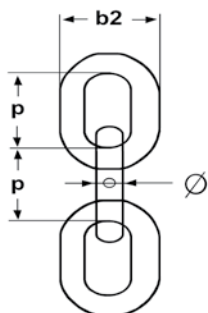
**8300****ŁAŃCUCH KRÓTKIE OGNIWO - DIN 766**

					Stal A4 (316)
Ø	ilość metrów w opakowaniu	P	b2	U (kg)	NR ART.
2	100	12	8	125	8300402
3	100	16	11	280	8300403
4	50	16	14	800	8300404
5	50	18,5	17	1250	8300405
6	50	18,5	20	1600	8300406
7	50	22	23	2500	8300407
8	50	24	26	3200	8300408
10	50	28	34	5000	8300410
13	50	36	44	8000	8300413

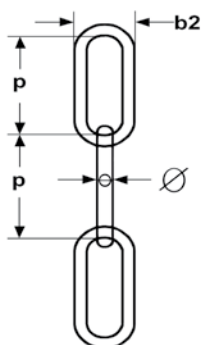
**8301****ŁAŃCUCH DŁUGIE OGNIWO DIN 763**

					Stal A4 (316)
Ø	ilość metrów w opakowaniu	P	b2	U (kg)	NR ART.
2	100	22	8	125	8301402
3	100	26	12	280	8301403
4	50	32	16	630	8301404
5	50	35	20	1000	8301405
6	50	42	24	1250	8301406
8	50	52	32	2500	8301408
10	50	65	40	4000	8301410
13	50	82	52	6300	8301413

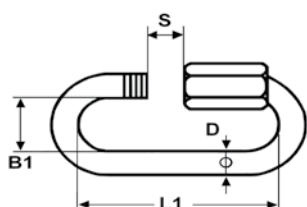
**8253****ZŁĄCZKA**

					Stal A4 (316)
D	L1	B1	S	NR ART.	
4	32	12	5,5	8253404	
5	39	13	6,5	8253405	
6	45	14	7,5	8253406	
8	58	18	9,5	8253408	
10	69	22	12	8253410	
12	81	24	14,5	8253412	

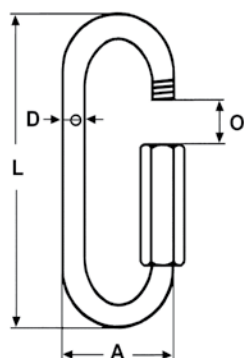
**8838****ZŁĄCZKA**

					Stal A4 (316)
D	L	O	A	U (kg)	NR ART.
3,5	40	8,5	8,5	160	8838403
4	53	11,5	11,5	640	8838404
5	62	13	13	750	8838405
6	70	14,5	14,5	1400	8838406
8	88	17,5	17,5	2800	8838408
10	105	20,5	20,5	4000	8838410
12	124	23,5	23,5	5000	8838412

**8489**

**ZŁĄCZKA**

Stal A4 (316)

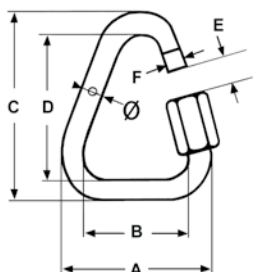

G	A	B	C	D	E	F	NR ART.
4	34	26	39	31	5,5	6	8489404
5	39	30	47	38	6	7	8489405
6	47	34	55	44	7	9	8489406
8	55	39	72	56	9	12	8489408
10	66	46	86	66	12	15	8489410

**8231**

**ZAWIAS**

Stal A4 (316)

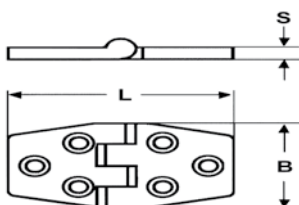

L	B	S	NR ART.
76	38	4	82314076
100	38	4	82314100

**8234**

**ZAWIAS**

Stal A4 (316)

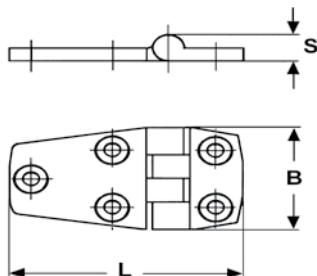

L	B	S	NR ART.
56	38	4	82345638
76	38	4	82347638

**8235**

**ZAWIAS**

Stal A4 (316)

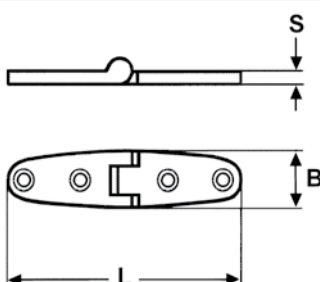

L	B	S	NR ART.
100	25	4	8235410025

**8236**

**ZAWIAS**

Stal A4 (316)

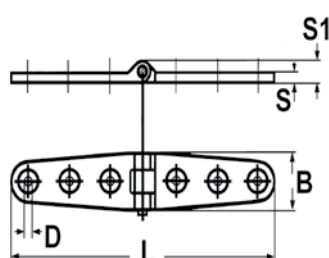

L	B	S	NR ART.
160	27	4	8236416027

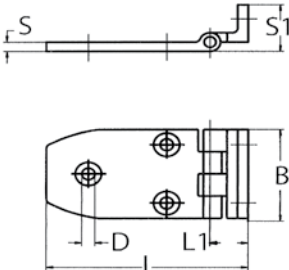
8237	ZAWIAS				Stal A4 (316)
	L	B	S	S1	NR ART.
	56	28	4	9,5	823745638
	76	28	4	9,5	823747638

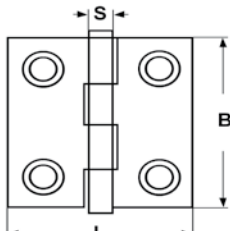
8233	ZAWIAS			Stal A4 (316)
	L	B	S	NR ART.
	38	38	4	823343838
	50	50	4	823345050

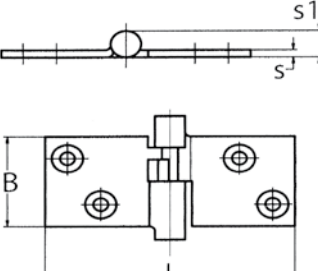
8239	ZAWIAS			Stal A4 (316)
	L	B	S	NR ART.
	90	38	3	823949038

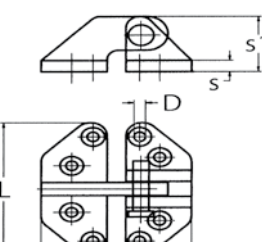
8238	ZAWIAS			Stal A4 (316)
	L	B	S	NR ART.
	74	65	6	823847465

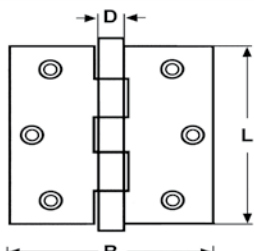
8514	ZAWIAS				Stal A4 (316)
	D	L	B	S	NR ART.
	10	75	75	2	851427575

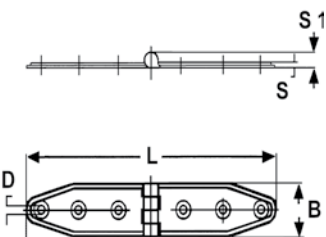

8573	ZAWIAS						Stal A4 (316)
	L	L1	B	D	S	S1	NR ART.
	160	80	28	4,5	3	8	8573216028

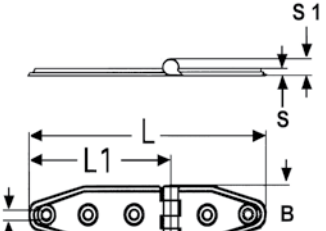
8574	ZAWIAS						Stal A4 (316)
	L	L1	B	D	S	S1	NR ART.
	133	80	28	4,5	3	8	8574213328

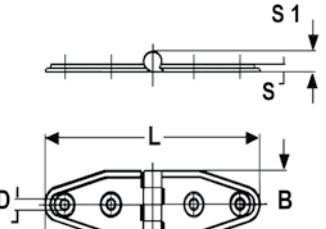
8575	ZAWIAS						Stal A4 (316)
	L	L1	B	D	S	S1	NR ART.
	105	53	28	4,5	3	8	8575210528

8569	ZAWIAS						Stal A4 (316)
	L	L1	B	D	S	S1	NR ART.
	38	19	38	5,5	2	9	856923838
68	34	38	5,5	2	9	856926838	

8568	ZAWIAS						Stal A4 (316)
	L	L1	B	D	S	S1	NR ART.
	58	40	38	5,5	2	9	856825838
68	49	38	5,5	2	9	856826838	

**8513**

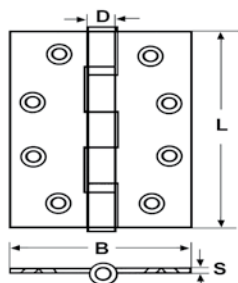

**ZAWIAS**

					Stal A4 (316)
D	L	B	S	NR ART.	
11	100	75	2,5	8513210075	

**8512**

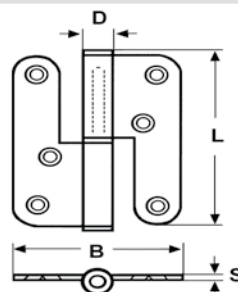

**ZAWIAS**

					Stal A4 (316)
FORMA	D	L	B	S	NR ART.
PRAWY	14	100	80	3	8512210080PR
LEWY	14	100	80	3	8512210080LE

**814033**

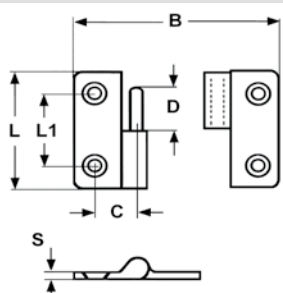

**ZAWIAS**

							Stal A4 (316)
FORMA	L	B	S	L1	C	D	NR ART.
PRAWY	37	37	2,6	23	12,5	13,5	81403343737PR
LEWY	37	37	2,6	23	12,5	13,5	81403343737LE

**8429**

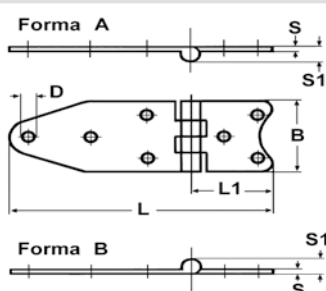

**ZAWIAS**

							Stal A4 (316)
FORMA	L	B	L1	S	D	S1	NR ART.
A	129	40	38	2	5	9	8429212940A
B	129	40	38	2	5	9	8429212940B

**8430**

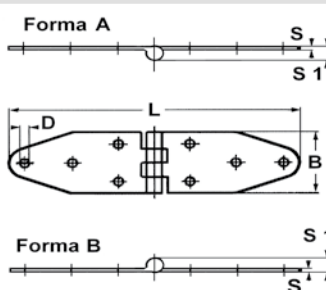

**ZAWIAS**

						Stal A4 (316)
FORMA	L	B	D	S	S1	NR ART.
A	180	40	5	2	9	8430218040A
B	180	40	5	2	9	8430218040B

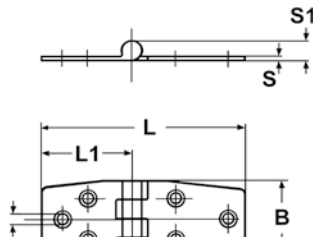
8578	ZAWIAS						Stal A4 (316)
	L	L1	B	D	S	S1	NR ART.
	87	38	38	5,4	2	9	857828738
	97	40	38	5,4	2	9	857829738

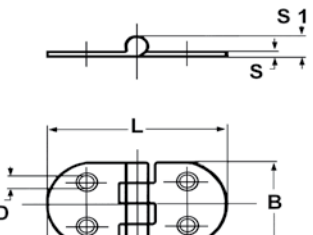
8572	ZAWIAS						Stal A4 (316)
	L	L1	B	D	S	S1	NR ART.
	75	37,5	38	5,5	2	9	857227538

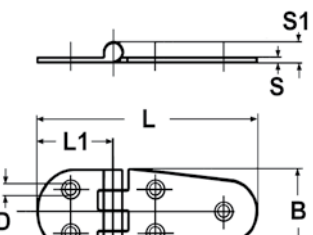
8571	ZAWIAS						Stal A4 (316)
	L	L1	B	D	S	S1	NR ART.
	110	38	38	5,5	2	9	8571211038

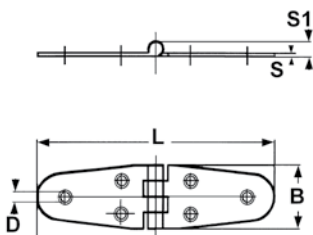
8570	ZAWIAS						Stal A4 (316)
	L	L1	B	D	S	S1	NR ART.
	145	72,5	38	5,5	2	9	8570214538

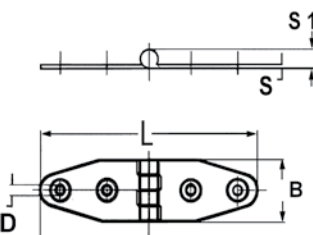
8576	ZAWIAS						Stal A4 (316)
	L	L1	B	D	S	S1	NR ART.
	100	50	28	5,5	2	9	8576210028

**8577**

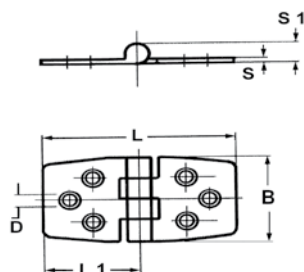

**ZAWIAS**

ZAWIAS						Stal A4 (316)
L	L1	B	D	S	S1	NR ART.
75	37,5	38	5,4	2	9	857727538
97	48,5	38	5,4	2	9	857729738

**8567**

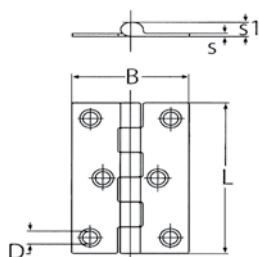

**ZAWIAS**

ZAWIAS						Stal A4 (316)
L	B	D	S	S1	NR ART.	
50	35	3,3	1,7	8	8567205035	
62	40	3,3	1,7	8	8567206240	
75	48	5,5	1,7	8	8567207548	
100	54	6,6	1,7	8	8567210054	

**8896**

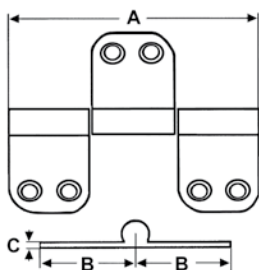

**ZAWIAS**

ZAWIAS			Stal A4 (316)
A	B	C	NR ART.
98	37	1,5	889649837

**8859**

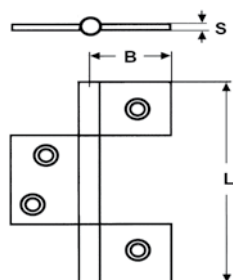

**ZAWIAS**

ZAWIAS			Stal A4 (316)
L	B	S	NR ART.
85	30	1,5	8859485

**8858**

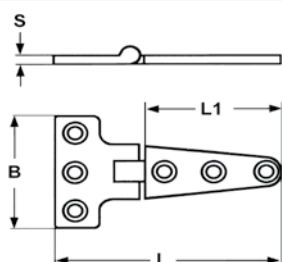

**ZAWIAS**

ZAWIAS					Stal A4 (316)
L	L1	B	S	NR ART.	
100	60	54	4	88584100	
152	100	75	4	88584152	
197	140	98	4	88584197	

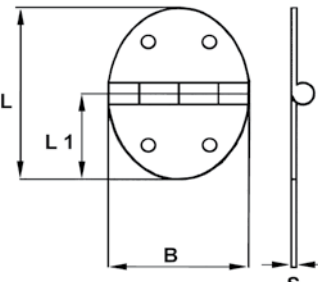
	ZAWIAS				Stal A4 (316)
	L	L1	B	S	NR ART.
	51	25,5	35	2	890325135

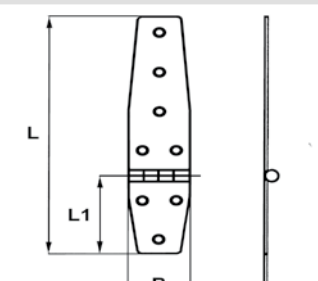
	ZAWIAS				Stal A4 (316)
	L	L1	B	S	NR ART.
	180	60	38	2	8982218038

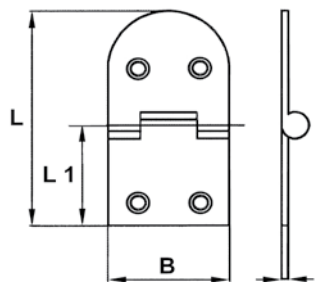
	ZAWIAS				Stal A4 (316)
	L	L1	B	S	NR ART.
	70	35	38	2	890427038

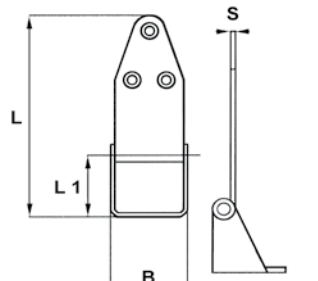
	ZAWIAS				Stal A4 (316)
	L	L1	B	S	NR ART.
	127	27	47	2,5	8905212747

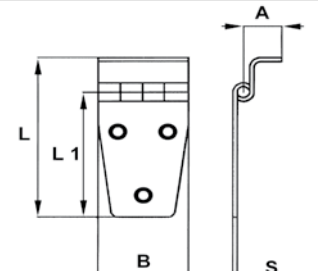
	ZAWIAS					Stal A4 (316)
	L	B	A	L1	S	NR ART.
	65	38	21	45	2	89062653821
	76	38	35	45	2	89062653835

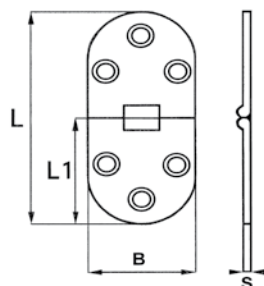
**8897****ZAWIAS**

Stal A4 (316)

L	L1	B	S	NR ART.
66	33	30	2,0	889746630

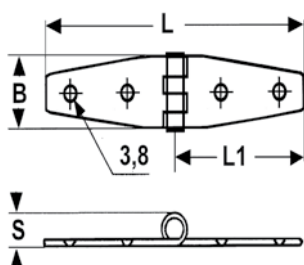
**8900****ZAWIAS**

Stal A4 (316)

L	L1	B	S	NR ART.
102	51	27	2	8900210227

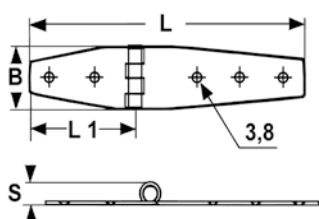
**8981****ZAWIAS**

Stal A4 (316)

L	L1	B	S	NR ART.
135	50	27	2	8981213527

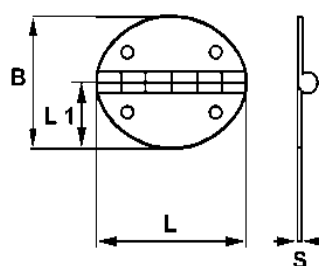
**8901****ZAWIAS**

Stal A4 (316)

B	L1	L	S	NR ART.
78	28	56	2	890127856

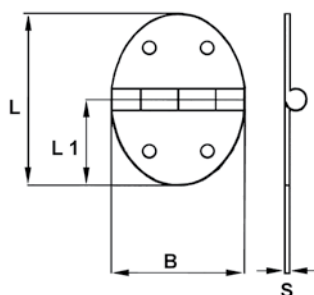
**8902****ZAWIAS**

Stal A4 (316)

L	L1	B	S	NR ART.
67	35,5	48	2	890226748

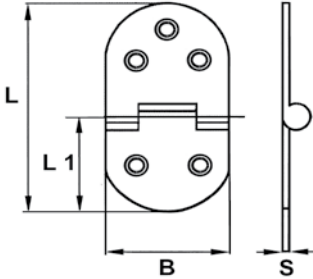
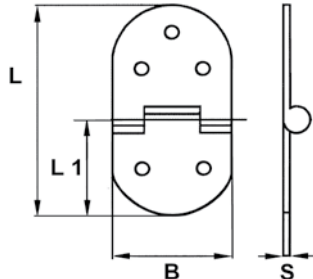
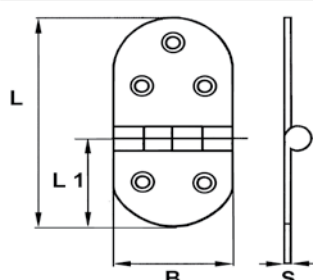
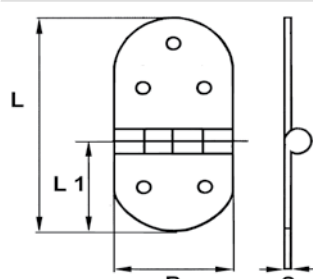
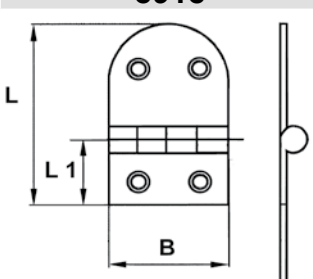
	<b>8914</b>	<b>ZAWIAS</b>			Stal A4 (316)	
		<b>L</b>	<b>L1</b>	<b>B</b>	<b>S</b>	<b>NR ART.</b>
		146	51	65	4	<b>8914414665</b>
	<b>8915</b>	<b>ZAWIAS BEZ OTWORÓW ( MOCOWANIE SWORZNIAMI )</b>			Stal A4 (316)	
		<b>L</b>	<b>L1</b>	<b>B</b>	<b>S</b>	<b>NR ART.</b>
		146	51	65	4	<b>8915414665</b>
	<b>8916</b>	<b>ZAWIAS</b>			Stal A4 (316)	
		<b>L</b>	<b>L1</b>	<b>B</b>	<b>S</b>	<b>NR ART.</b>
		145	50	65	4	<b>8916414550</b>
	<b>8917</b>	<b>ZAWIAS BEZ OTWORÓW ( MOCOWANIE SWORZNIAMI )</b>			Stal A4 (316)	
		<b>L</b>	<b>L1</b>	<b>B</b>	<b>S</b>	<b>NR ART.</b>
		190	95	65	4	<b>8916419065</b>
	<b>8918</b>	<b>ZAWIAS</b>			Stal A4 (316)	
		<b>L</b>	<b>L1</b>	<b>B</b>	<b>S</b>	<b>NR ART.</b>
		83	32	65	4	<b>891848365</b>

**8952****ZAWIAS**

Stal A4 (316)

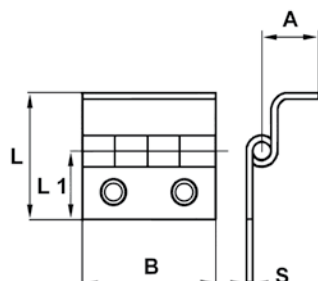

L	B	A	L1	S	NR ART.
35	38	20	15	2	895223538

**8910****ZAWIAS**

Stal A4 (316)

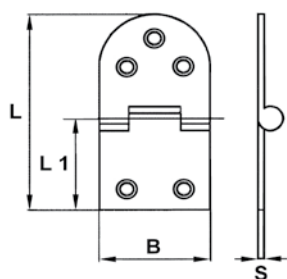

L	L1	B	S	NR ART.
76	30	40	4	891047640

**8911****ZAWIAS BEZ OTWORÓW ( MOCOWANIE SWORZNIAMI )**

Stal A4 (316)

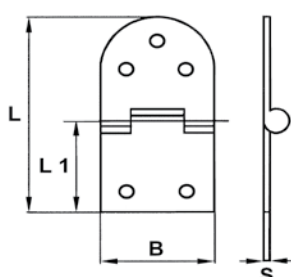

L	L1	B	S	NR ART.
76	30	40	4	891147640

**8912****ZAWIAS**

Stal A4 (316)

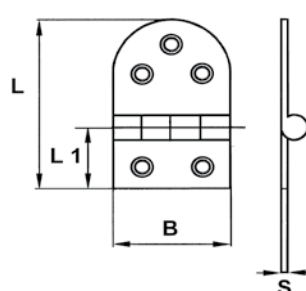

L	L1	B	S	NR ART.
134	21	65	4	8912413465

**8913****ZAWIAS BEZ OTWORÓW ( MOCOWANIE SWORZNIAMI )**

Stal A4 (316)

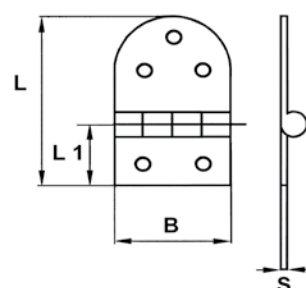

L	L1	B	S	NR ART.
134	21	65	4	8913413465

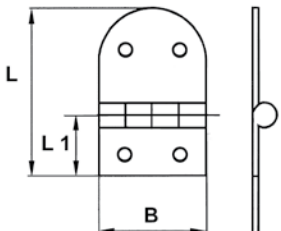

8919	ZAWIAS BEZ OTWORÓW ( MOCOWANIE SWORZNIAMI )				Stal A4 (316)
	L	L1	B	S	NR ART.
	83	32	65	4	891948365

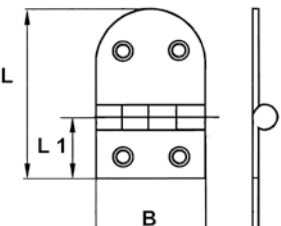
8920	ZAWIAS				Stal A4 (316)
	L	L1	B	S	NR ART.
	72	21	65	4	892047265

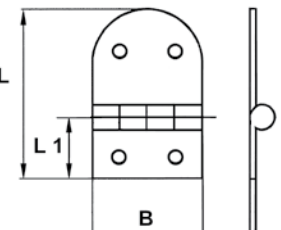
8921	ZAWIAS BEZ OTWORÓW ( MOCOWANIE SWORZNIAMI )				Stal A4 (316)
	L	L1	B	S	NR ART.
	72	21	65	4	892147265

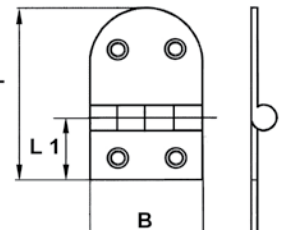
8922	ZAWIAS				Stal A4 (316)
	L	L1	B	S	NR ART.
	103	21	65	4	8922410365

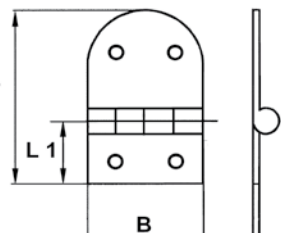
8923	ZAWIAS BEZ OTWORÓW ( MOCOWANIE SWORZNIAMI )				Stal A4 (316)
	L	L1	B	S	NR ART.
	103	21	65	4	8923410365

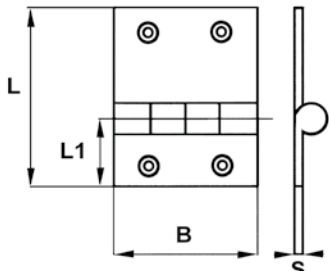
8924	ZAWIAS				Stal A4 (316)
	L	L1	B	S	NR ART.
	52	19	61	4	892445261

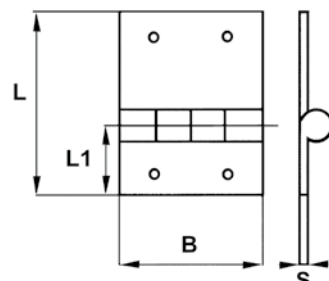
8925	ZAWIAS BEZ OTWORÓW ( MOCOWANIE SWORZNIAMI )				Stal A4 (316)
	L	L1	B	S	NR ART.
	52	19	61	4	892545261

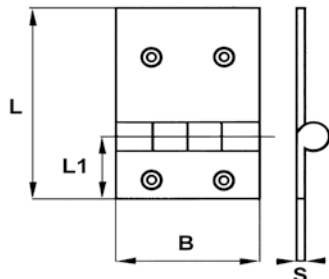
8926	ZAWIAS				Stal A4 (316)
	L	L1	B	S	NR ART.
	80	33	65	4	892648065

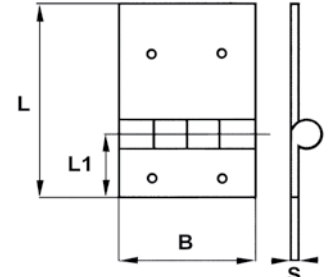
8927	ZAWIAS BEZ OTWORÓW ( MOCOWANIE SWORZNIAMI )				Stal A4 (316)
	L	L1	B	S	NR ART.
	80	33	65	4	892748065

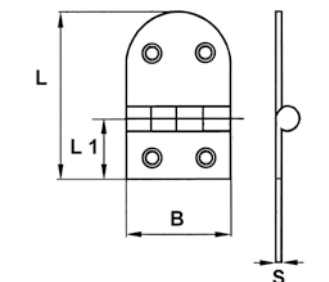
8928	ZAWIAS				Stal A4 (316)
	L	L1	B	S	NR ART.
	70	30	40	4	892847040

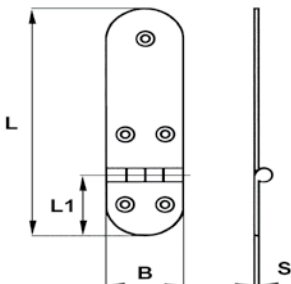
8930		ZAWIAS				Stal A4 (316)	
		L	L1	B	S	NR ART.	
		126	40	40	4	8930412640	

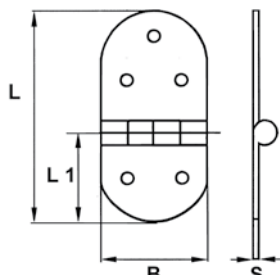
8931		ZAWIAS BEZ OTWORÓW ( MOCOWANIE BOLCAMI )				Stal A4 (316)	
		L	L1	B	S	NR ART.	
		126	40	40	4	8931412640	

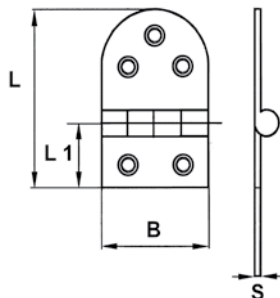
8932		ZAWIAS				Stal A4 (316)	
		L	L1	B	S	NR ART.	
		127	32	65	4	8932412765	

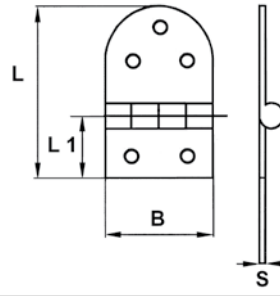
8933		ZAWIAS BEZ OTWORÓW ( MOCOWANIE SWORZNIAMI )				Stal A4 (316)	
		L	L1	B	S	NR ART.	
		127	32	65	4	8933412765	

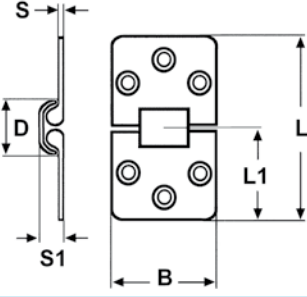
8670		ZAWIAS						Stal A4 (316)	
		L	L1	B	D	S	S1	NR ART.	
		70	35	42	6	2,2	7,5	8670407042	

8671	ZAWIAS						Stal A4 (316)
	L	L1	B	D	S	S1	NR ART.
	52	26	42	6	2,2	7,5	8671405242

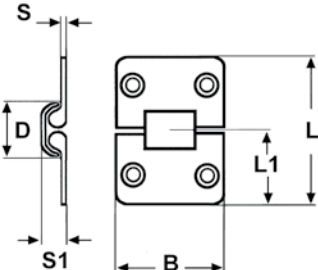

8678	ZAWIAS						Stal A4 (316)
	L	L1	B	D	S	S1	NR ART.
	65	32,5	65	7,5	2	9	8678406565

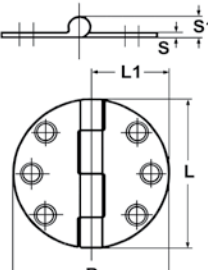

8676	ZAWIAS						Stal A4 (316)
	L	L1	B	D	S	S1	NR ART.
	74	37	0	5,5	2	9	8676407440

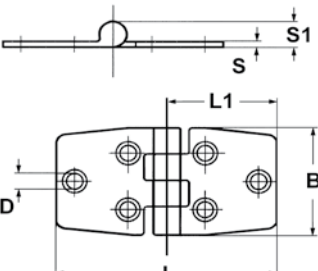

8677	ZAWIAS						Stal A4 (316)
	L	L1	B	D	S	S1	NR ART.
	75	37	74	7,5	2	9	8677407574

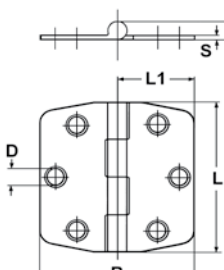

8675	ZAWIAS						Stal A4 (316)
	L	L1	B	D	S	S1	NR ART.
	57	18	37	6	2	9	8675405737

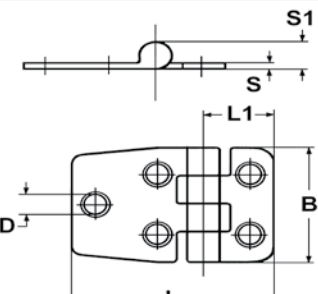

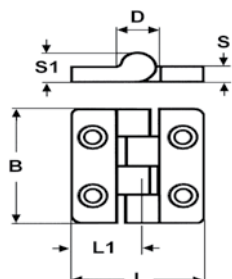
**8674****ZAWIAS**

Stal A4 (316)

L	L1	B	D	S	S1	NR ART.
36	18	36	6	2	9	8674403636

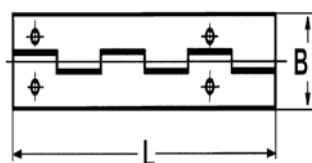
**8321****ZAWIAS**

Stal A4 (316)

siła rozciągania	B	L	NR ART.
0,7	16	3500	832120716
0,7	18	3500	832120718
0,7	20	3500	832120720
0,7	25	3500	832120725
0,7	32	3500	832120732
0,7	40	3500	832120740
1,5	32	2000	832121532
1,5	40	2000	832121540

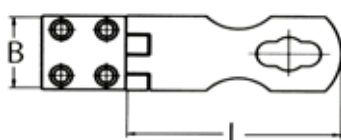
**8428****SKOBEL**

Stal A4 (316)

L	B	NR ART.
71	24	842827124

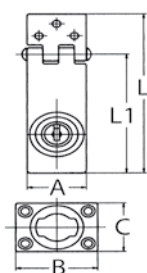
**8588****SKOBEL Z ZAMKNIĘCIEM**

Stal A4 (316)

A	B	C	L1	L2	NR ART.
30	42	30	98	75	8588230

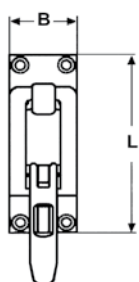
**8854****SKOBEL**

Stal A4 (316)

L	B	NR ART.
80	28	885448028

**8217**

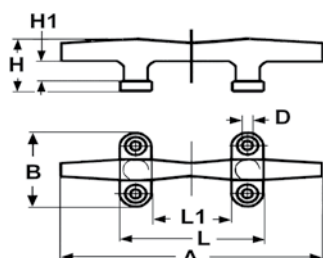

**KNAGA**

								Stal A4 (316)
H	H1	B	A	L	L1	D	NR ART.	
24	16	36	100	40	18	5,4	82174100	
27	19	40	124	50	25	4,8	82174125	
31	20	46	151	74	40	6,5	82174150	
39	24	55	200	93	53	6,5	82174200	
45	31	64	243	109	70	7,6	82174250	
55	31	71	303	122	78	7,6	82174300	

**8218**

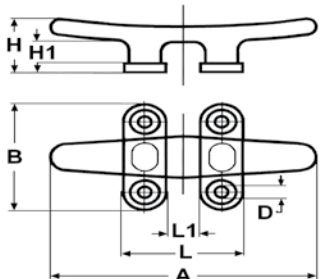

**KNAGA**

								Stal A4 (316)
H	H1	B	A	L	L1	D	NR ART.	
22	15	36	98	42	17	4,6	82184100	
25	19	46	124	26	56	5,5	82184125	
29	20	60	141	70	33	6,1	82184150	
40	29	60	200	80	34	6,5	82184200	
41	28	65	239	78	29	7,6	82184250	

**8221**

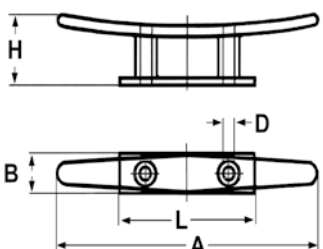

**KNAGA**

							Stal A4 (316)
A	B	H	D	L	NR ART.		
100	14	23,5	14	50	82214100		
125	15	30	16	65	82214125		
150	20	32	22	75	82214150		
200	23	42	25	80	82214200		
250	25	52	28	105	82214250		

**8529**

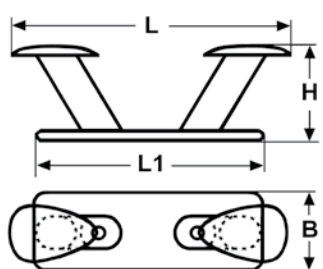

**POLER**

						Stal A4 (316)
L	L1	B	H	NR ART.		
160	145	60	60	85294160		
200	170	70	70	85294200		
240	200	70	85	85294240		
300	255	80	100	85294300		
350	300	90	115	85294350		

**8680**

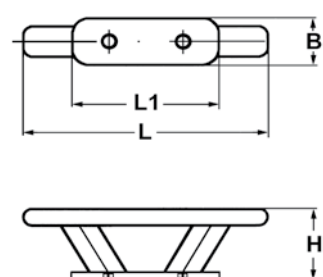

**KNAGA**

						Stal A4 (316)
L	L1	B	H	NR ART.		
150	90	30	45	8680415030		
200	120	35	54	8680420035		
250	150	40	70	8680425040		
300	160	40	80	8680430040		

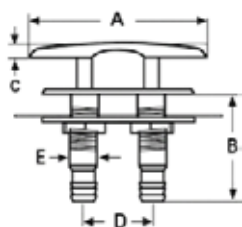
**8827****KNAGA**

Stal A4 (316)

A	B	C	D	E	NR ART.
150	60	4	57	22	88274150
200	70	5	70	25	88274200

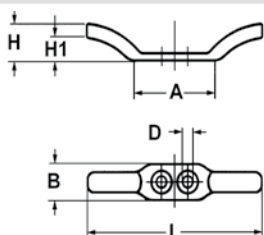
**8367****KNAGA**

Stal A4 (316)

L	B	NR ART.
50	10	8367250
80	10	8367280

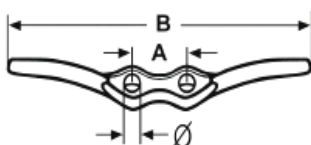
**8973****KNAGA**

Stal A4 (316)

Ø	A	B	NR ART.
4,5	10	68	89734068
5,8	21	114	89734114
6,7	24	150	89734150

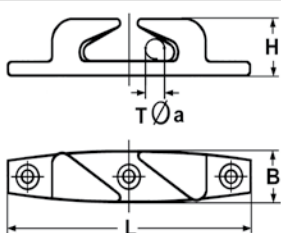
**8219****PRZEWŁOKA**

Stal A4 (316)

Długość	Szerokość	Cuma - Ø	NR ART.
115 L	23	10	8219L115
115 P	23	10	8219R115
150 L	35	16	8219L150
150 P	35	16	8219R150

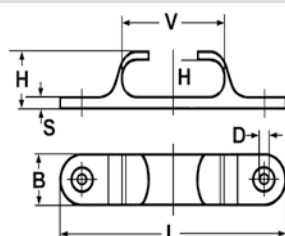
**8220****PRZEWŁOKA**

Stal A4 (316)

Długość	NR ART.
125	82204125
155	82204155

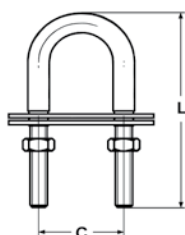
**8651****U-BOLT**

Stal A4 (316)

D	L	C	NR ART.
8	100	40	8651408100
10	100	40	8651410100
12	120	47	8651412120

**8230**

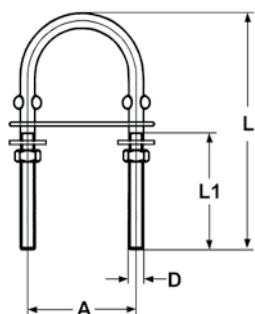

**U-BOLT**

D x L	A	L1	NR ART.
4 x 64	30	30	8230204064
5 x 80	35	40	8230205080
6 x 90	35	40	8230206090
8 x 80	35	40	8230208080
8 x 100	35	50	8230208100
10 x 90	50	40	8230210090
10 x 130	50	55	8230210130
12 x 150	60	65	8230212150

**Stal A4 (316)**

**8979**

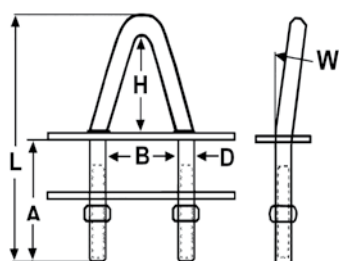

**U-BOLT Z GŁÓWKĄ KĄTOWĄ**

W	D	L	A	B	H	NR ART.
0°	8	100	50	33	40	897940800
8°	8	100	50	33	40	897940808
18°	8	100	50	33	40	897940818
0°	10	120	60	40	40	897941000
8°	10	120	60	40	40	897941008
18°	10	120	60	40	40	897941018

**Stal A4 (316)**

**8974**

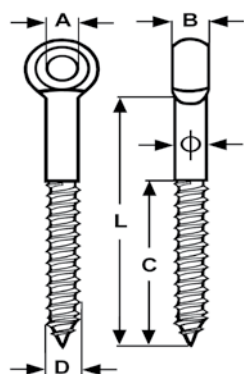

**WKREŃ OCZKOWY Z GWINTEM DO DREWNA**

Ø	A	B	C	L	NR ART.
6	6,3	7	30	40	8974406040
6	6,3	7	35	50	8974406050
6	6,3	7	40	60	8974406060
8	8,4	9	40	60	8974408060
8	8,4	9	55	80	8974408080
8	8,4	9	65	100	8974408100
10	10,2	11	55	80	8974410080
10	10,2	11	65	100	8974410100
10	10,2	11	80	120	8974410120
12	12,1	13	65	100	8974412100
12	12,1	13	80	120	8974412120

**Stal A4 (316)**

**8473**

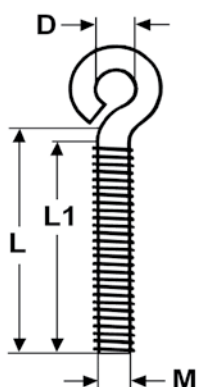

**WKREŃ OCZKOWY Z GWINTEM METRYCZNYM**

M	L	L1	D	NR ART.
5	30	27	8	847320530
5	40	37	8	847320540
5	50	47	8	847320550
6	20	18	10	847320620
6	30	27	10	847320630
6	40	37	10	847320640
6	60	57	10	847320660
8	60	57	10	847320860
8	80	77	10	847320880
10	70	65	15	847321070

**Stal A4 (316)**